

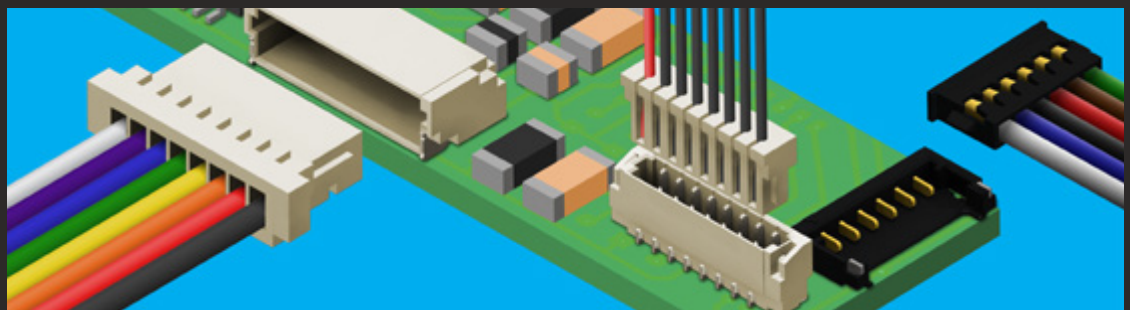

**Board to Board Connectors
Coaxial Cable Assemblies
SIM Card Connectors
Wire to Board Solutions**

2019 Edition

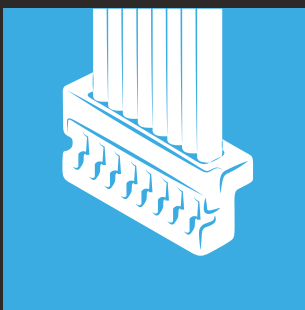
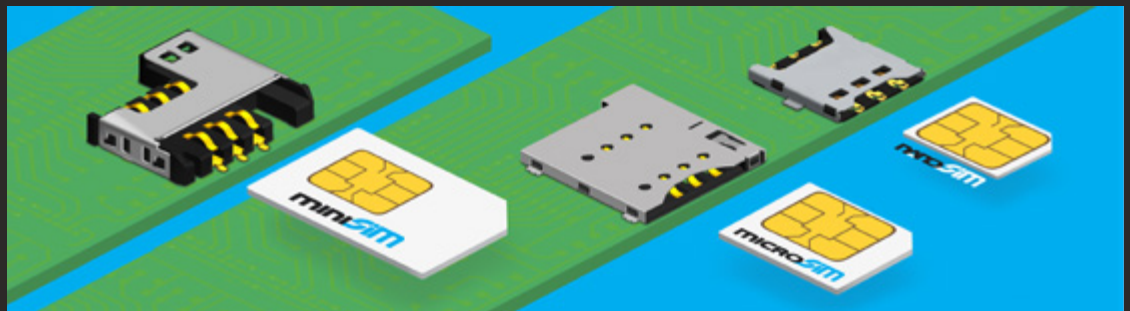
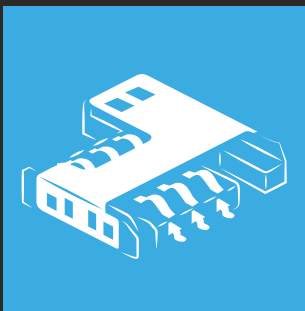
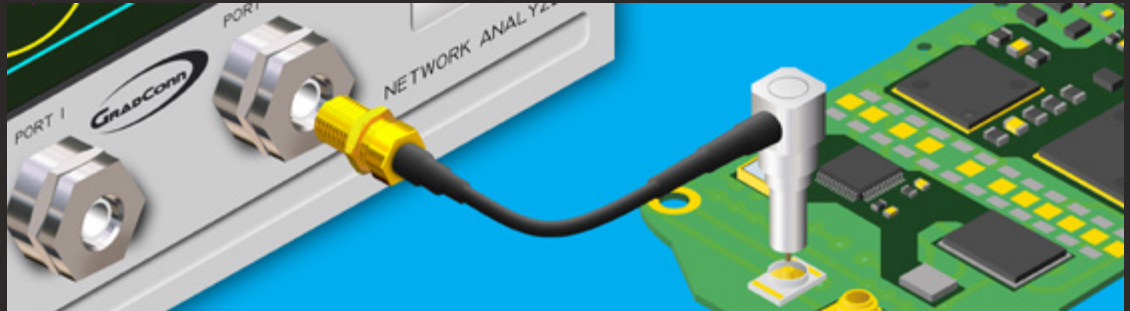
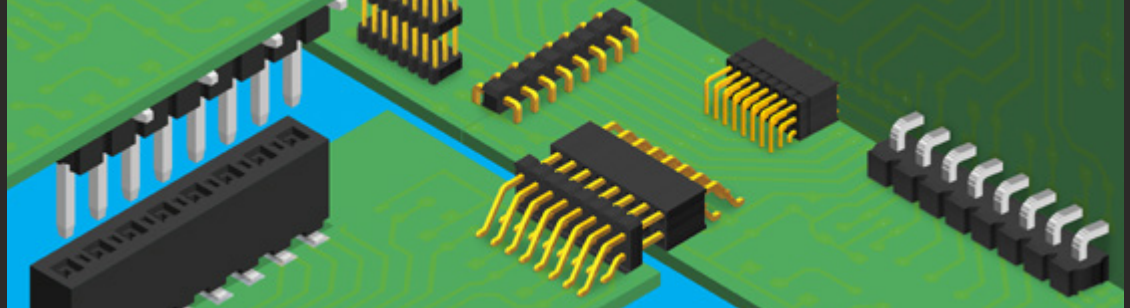
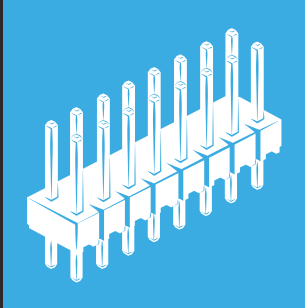

NEW FROM **GRADCONN**

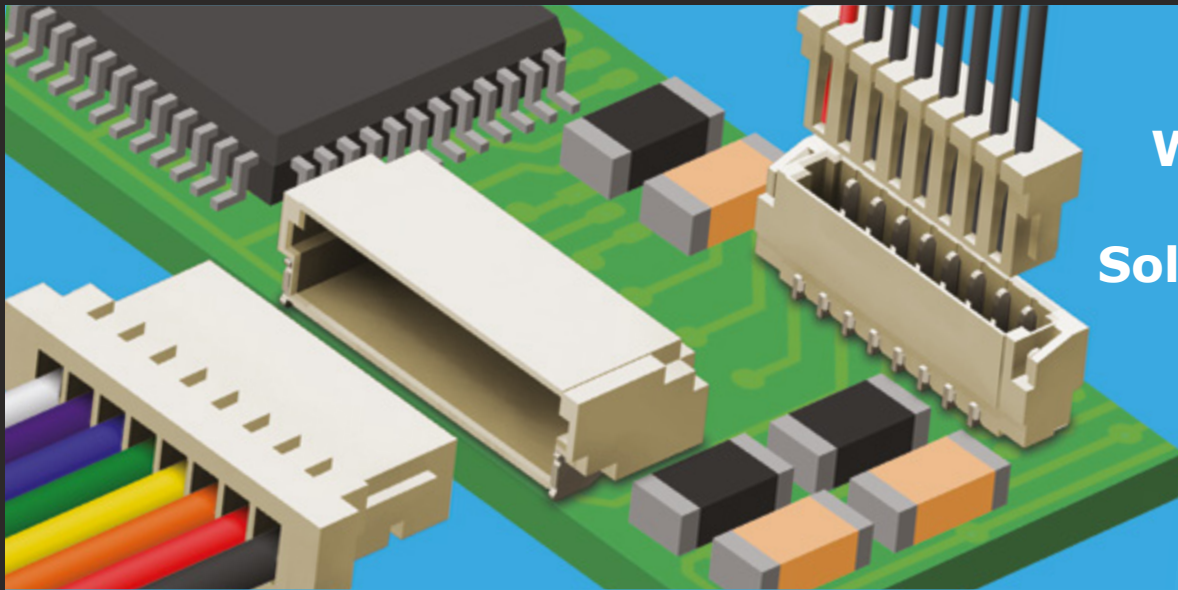

**Wire to
Board
Solutions**

Page 26

NAUTILUS

**Nautilus
Waterproof
Coaxial Connectors
and Cable Assemblies**

Page 32

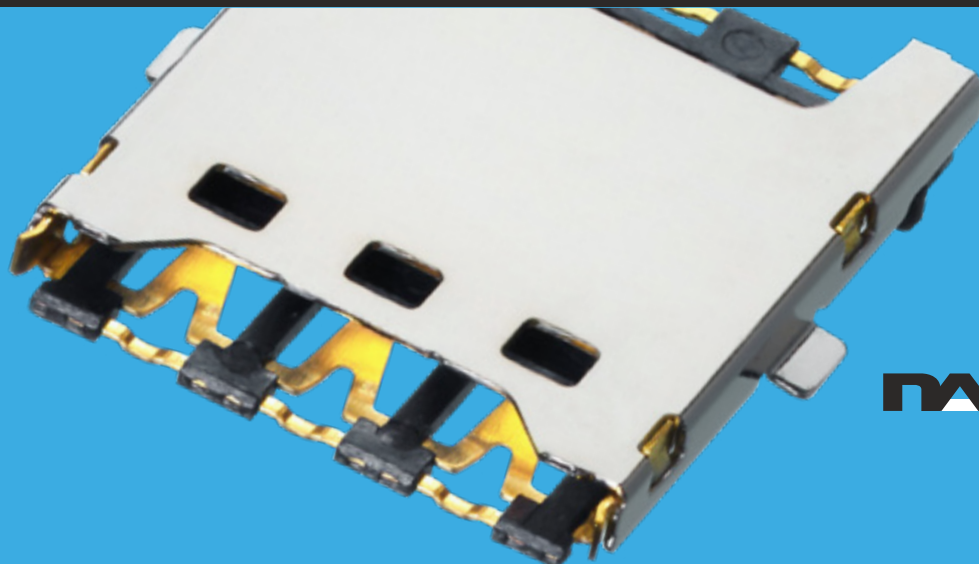

mosim
(4ff)

Page 36

Contents

About GradConn	2
Board to Board Connectors	3
PCB Stacking Solutions	4
PCB Right Angle & Planar Mating Solutions	7
Plating & Materials	8
Contact Styles, Boxed & Polarised Parts	9
Custom Solutions	10
1.00mm (.039")	11
0.80mm x 1.20mm (.031" x .047")	12
1.27mm (.050")	13
1.27mm x 2.54mm (.050" x .100")	15
2.00mm (.079")	16
2.54mm (.100")	19
3.96mm (.156")	22
5.08mm (.200")	23
Wire to Board Connectors	26
0.80mm (.031") & 1.00mm (.039")	27
1.20mm (.047")	28
Coaxial Cable Assemblies	29
Connector Types	30
Cable Information	31
Nautilus Waterproof Cable Assemblies	32
Test Probes	34
SIM Card Connectors	35
Nano SIM	36
Micro SIM	37
Mini SIM - Push-Push	38
Mini SIM - Push-Pull	39
Mini SIM - Hinged	40
Mini SIM - Dual	41
Mini SIM - Contact	41

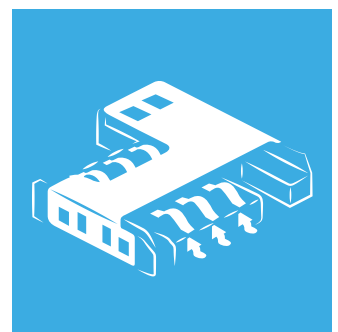
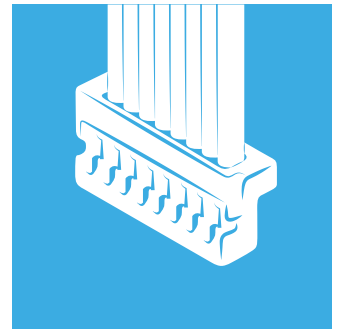
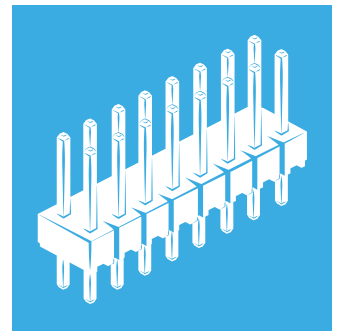

Contents

About GradConn

GradConn is a leading global connector manufacturer specialising in PCB connectors and cable assemblies. Based in Taiwan with manufacturing facilities in China and Taiwan certified to ISO9001:2008, we offer high quality components at an economical cost.

Our global footprint includes offices in Europe and North America with an extensive distribution and representative network. Our aim is to offer an expert local contact in your time zone, wherever you are in the world.

GradConn is committed to offering you the best service from design through to volume production. Trust us to work in partnership with your design and manufacturing teams in every step of your process wherever you're located.

To aid our customers GradConn offer an easy to use and interactive website with many useful features, including design and application advice, a cross-reference service, free fast samples and help with pre-production requirements. All of these services help bring your designs to market fast.

Environmental Compliance

RoHS

GradConn are committed to supply products that meet the requirements of the Restriction of Hazardous Substances directive 2011/65/EU, including Deca BDE. Each product drawing is marked in the top-right corner to confirm products are compliant.

Reach

Gradconn has reviewed its product range; currently we do not have any items with a chemical content that necessitates registration under the REACH Directive (EC)1907/2006. We are committed to reviewing updates to the directive as and when they happen.

ISO14001:2004

GradConn Ltd are committed to identify and control the environmental impact of its activities.

Conflict materials and Ethical Supply chain

GradConn's goal is to maintain the highest standards of ethical conduct and integrity in all areas of our business and activities, including within our supply chain and from materials which may be fuelling human rights abuses.

Find all certification and formal statements online at www.gradconn.com

Catalogue Information

It is our aim for this catalogue to be correct at the time of going to press. All contents are subject to change without notice. Please always check the latest drawings at www.gradconn.com

PCB Board to Board Connectors

Available in single, dual row, triple and quad row in through-hole and surface mount termination, GradConn offer a huge range of board to board PCB header and socket connectors in pin spacing pitches from 1.0mm (.039") through to 5.08mm (.200"). Headers and sockets have a contact range from 2 to 120 and are available in vertical and horizontal orientation.

Range Overview & Capability

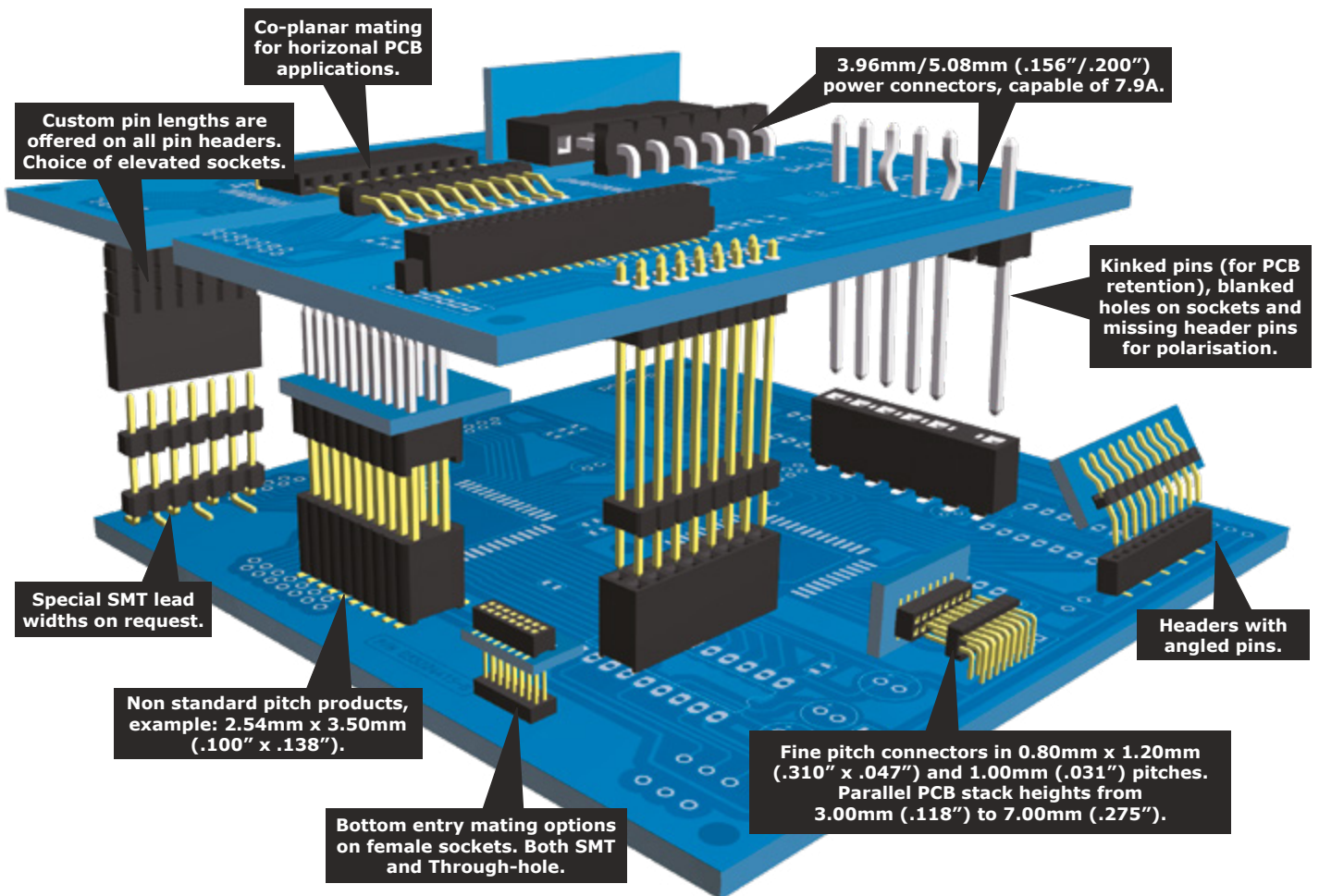



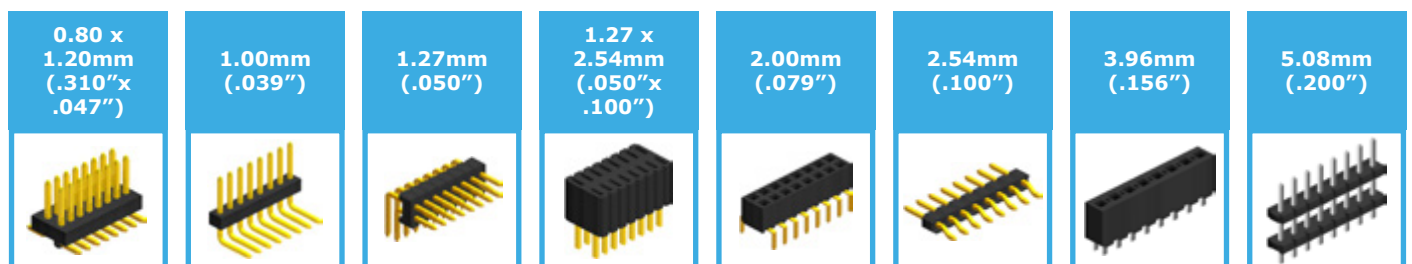

Connector Pitches

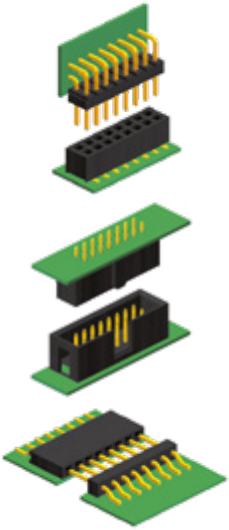

PCB Stacking

PCB Mating Options by Pitch



Pitch	Orientation		
	 Right Angle	 Parallel	 Planar
0.80x1.20mm (.031x.047")		●	
1.00mm (.039")	●	●	●
1.27mm (.050")	●	●	
1.27x2.54mm (.050x.100")	●	●	
2.00mm (.079")	●	●	●
2.54mm (.100")	●	●	●
3.96mm (.156")	●	●	
5.08mm (.200")	●	●	

Parallel Stacking - Elevated Headers

Board to Board

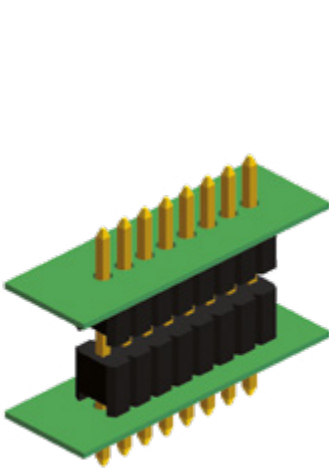

Header - 2 boards

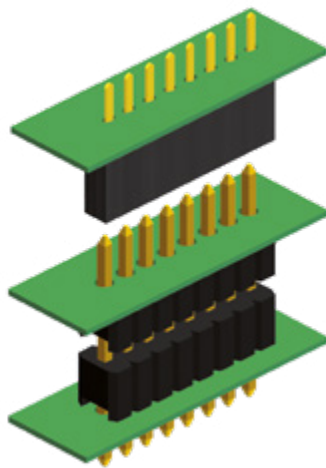

Header & Socket - 3 boards

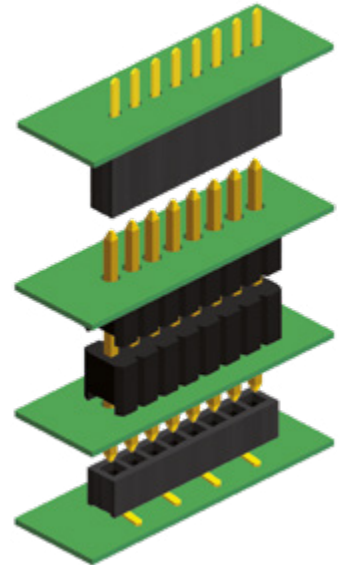

Header & 2 Sockets - 4 boards

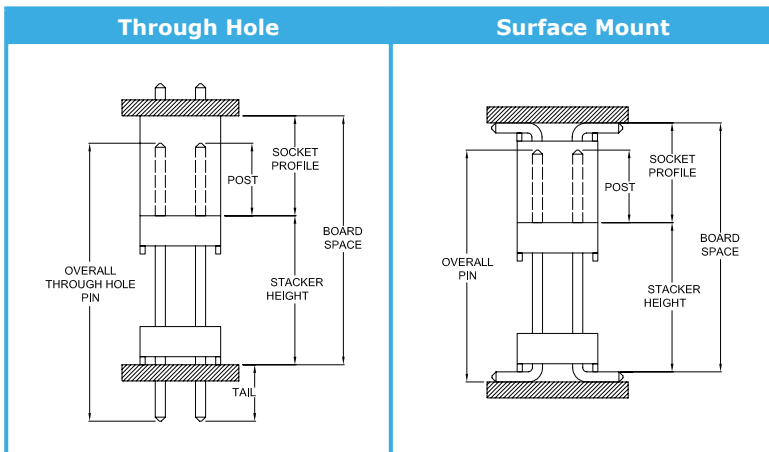

2.54mm (.100") - Through Hole		
Socket BB02 - KH	Header BB02 - TG	Total Board Spacing
Socket Profile	Stacker Height	
7.10mm (.280")	20.00mm (.787")	27.10mm (1.067")

1.00mm (.039") - Surface Mount		
Socket BB02 - WA	Header BB02 - TG	Total Board Spacing
Socket Profile	Stacker Height	
2.40mm (.094")	10.00mm (.393")	12.40mm (.488")

PCB Parallel Stacking

Gradconn offer a large range of board to board connectors for parallel PCB mating. The PCB connector stacking guide allows a simple step-by-step system to find the perfect mating connector design solution. You'll be guided to the lowest cost option, helping you design in the perfect balance of a suitable design solution at a great price!

Simply enter the PCB stacking dimension required, then use the narrow your search filter which allows multiple choices for you to compare and contrast solutions. The search displays results 0.5mm either side of your required PCB stack height to offer alternative options where your design is flexible.

Search by:

- Stacking Heights: From 3.0mm (.118") to 60.0mm (2.262").
- Connector Pitch: From 1.00mm (0.039") to 5.08mm (0.200").
- Number of Rows: Single, dual, triple or quad row connectors.
- PCB Mount Type: Surface mount, through-hole or SMT mating with through hole.

Once you've found your perfect height solution, both halves of the connector may then be added to your shopping basket and samples ordered.

If you seek advice on PCB mating, speak to your local GradConn sales office, where there is always a connector expert on hand.

GradConn.com PCB Stacking Calculator

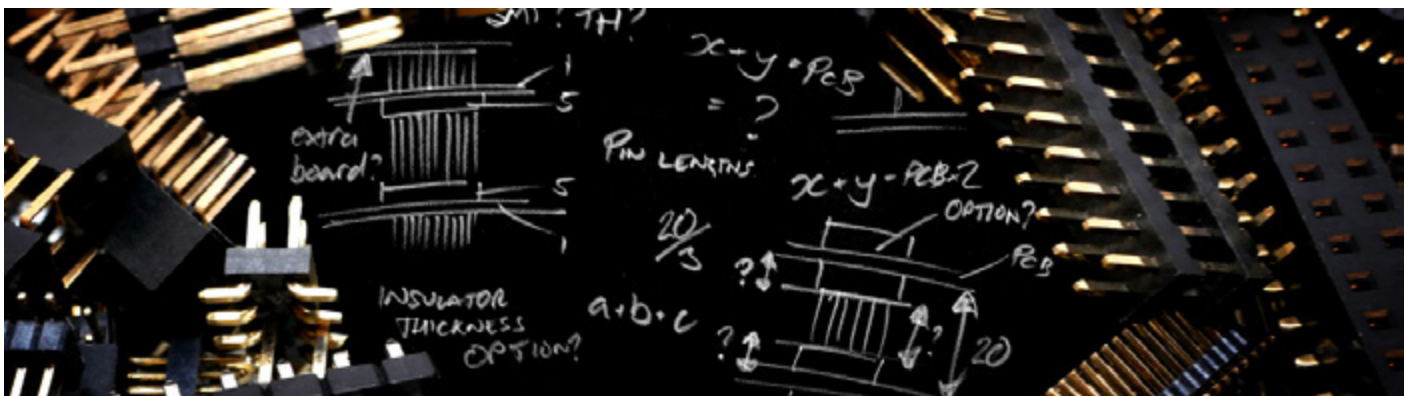

Finding the right connectors for a board stacking application can be time consuming. It can also be a struggle to work out which connectors are mating pairs, which stacking heights are possible and if they are available in the mounting style you need. Often it ends with a design compromise; connectors you can find, rather than the ideal combination, in the heights you actually need. You end up wasting time searching for product when you should in fact be working on the design!

GradConn helps you solve this problem. Even within our massive range of signal and power board to board connectors, our web-based parallel stacking calculator allows you to select products that match your actual requirement efficiently. Let this intuitive yet comprehensive navigation tool rapidly identify your optimal solution and best price.

www.GradConn.com/Products/BoardToBoard/PCBStacking

PCB Parallel Stacking

Bottom Entry Sockets

Bottom entry sockets (Through Hole and SMT) may be used to:

- Reduce distance between stacked PCB's.
- Allow 'plug up' applications for connection of three PCB's.
- To allow the use of single sided PCB's.

Style of Socket Mating

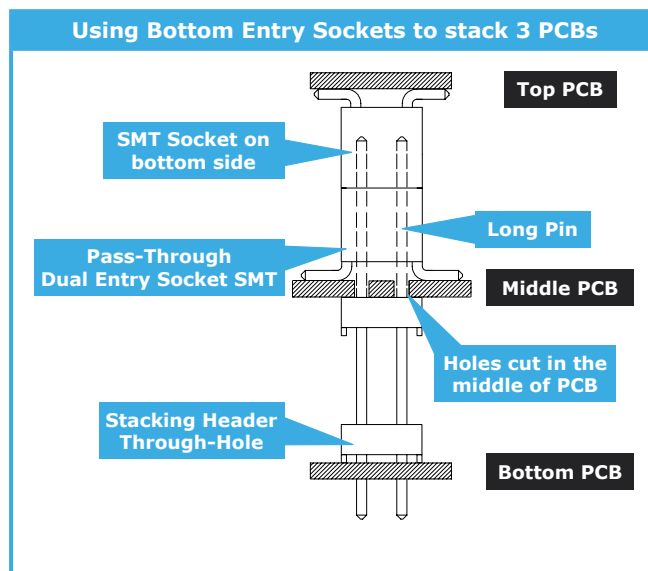
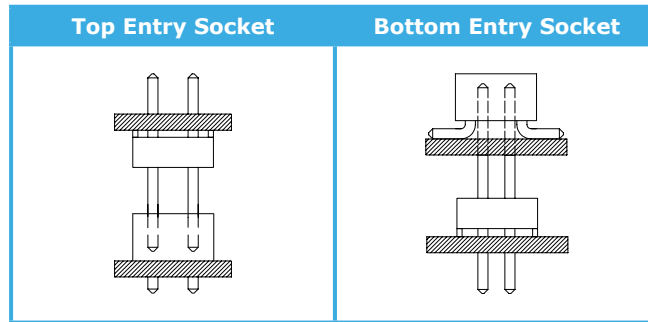

Check samples in your application before approval.

Stacking Sockets - Through Hole

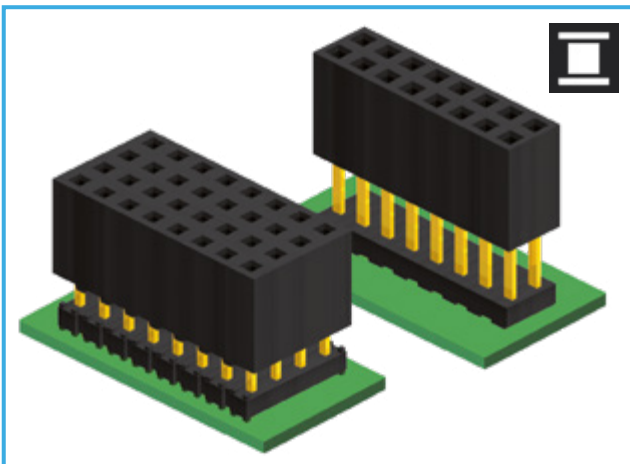

Pitch	SIL	DIL	Triple	Quad
2.00mm	n/a	BB02-GP	n/a	BB02-GW
2.54mm	BB02-JC	BB02-KD	BB02-LB	n/a

PCB Right Angle & Planar Mating

Right Angle Mating

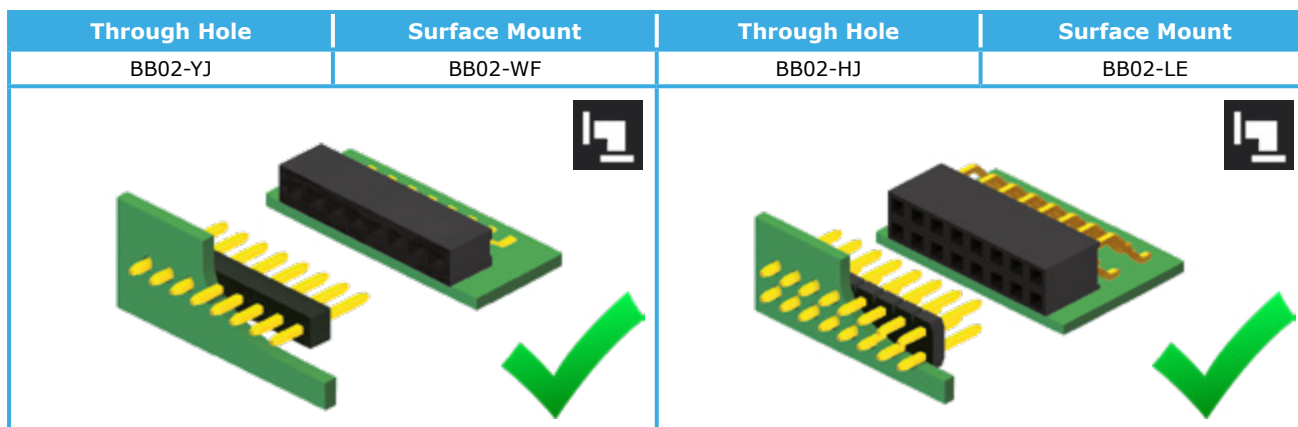

Planar (End-to-end) Mating

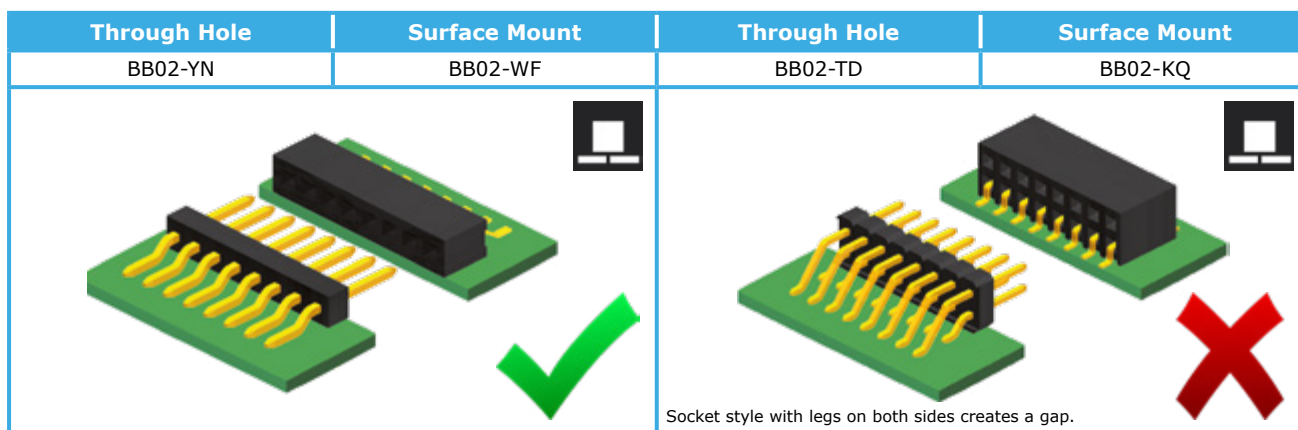

Pluggable Solutions

Pitch	Number of rows	Header	Socket	Height above PCB	Mount
1.00mm	1	BB02-YN	BB02-WF	1.50mm	Surface Mount
2.00mm	1	BB02-FB	BB02-RK	2.00mm	Through Hole
2.00mm	1	BB02-FK	BB02-RW	2.00mm	Surface Mount
2.00mm	2	BB02-FD	BB02-RL	4.00mm	Through Hole
2.00mm	2	BB02-RH	BB02-RX	4.00mm	Surface Mount
2.00mm	3	BB02-RR	BB02-RQ	6.00mm	Through Hole
2.54mm	1	BB02-HH	BB02-JS	2.50mm	Surface Mount
2.54mm	1	BB02-HA	BB02-JE	2.54mm	Through Hole
2.54mm	1	BB02-TK	BB02-JE	2.54mm	Through Hole
2.54mm	2	BB02-TH	BB02-LE	5.00mm	Surface Mount

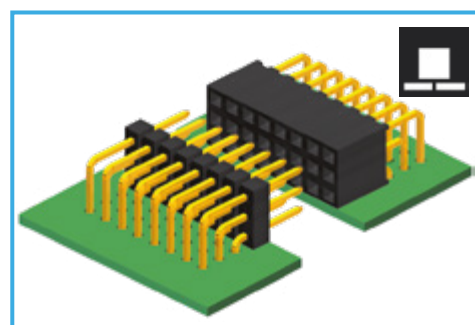

U-Shaped Solutions

Pitch	Number of rows	Header	Orientation	Height above PCB	Mount
1.27mm	1	BB02-5B	U Shaped	2.50mm	Through Hole
2.00mm	1	BB02-1F	U Shaped	2.00mm	Through Hole
2.00mm	1	BB02-2F	U Shaped	2.00mm	Through Hole
2.54mm	2	BB02-2H	U Shaped	5.00mm	Through Hole

BB02-1F/2F may be plugged directly into PCB or plugged into vertical sockets.

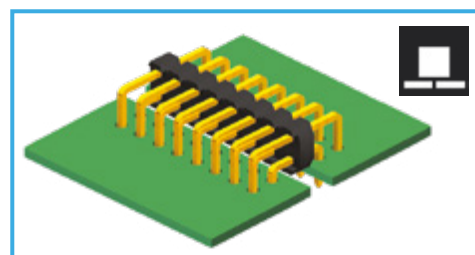

Insulators

Through Hole & SMT Connectors

Insulators are produced in Polyamide 6T (Nylon6T) or LCP as standard, both materials are suitable for with standing high temperature wave and reflow RoHS solder processes.

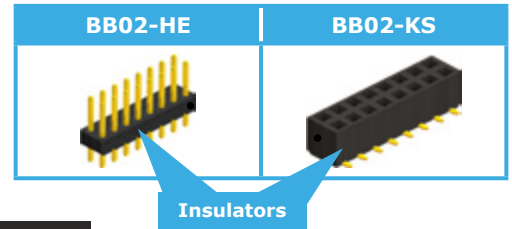

Pins & Contacts Base Materials

Base material of either Brass or Phosphor bronze depending on product.

Brass

- Lowest cost.
- Good spring properties and strength.
- Reasonably good conductor.

Phosphor Bronze

- Good strength and conductivity.
- Superior elasticity.
- Excellent fatigue resistance.

Plating

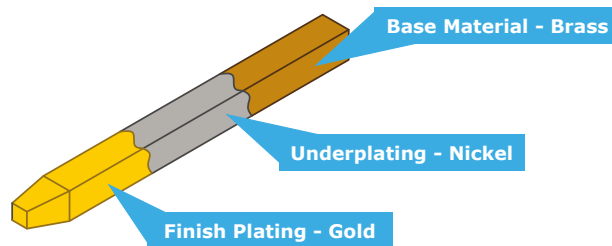

Base pins and contacts under-plated with nickel.

Finish plating added for improved conductivity, high temperature protection and resistance to corrosion and wear.

Finish plating is available in variants of gold and/or tin.

Gold

- Excellent corrosion resistance and durability.
- Excellent conductivity and low resistance.
- General Rule: Use thicker gold for applications above 100 cycles and less than 1 Amp.

Tin

- Excellent solderability and conductivity.
- Low durability and can form an oxide film.

Finish Plating options.

- Various levels of gold thickness available.
- Options for gold in contact area and tin in solder area (selective plating).
- Gold flash is standard - most economical and lowest MOQ.
- Tin - Bright or Matt.

Female Socket Contact Styles

Tuning Fork



Two points of contact.

Strengths

- Lower cost
- Higher retention force

Weaknesses

- Mating pin length limited
- Higher force required
- Top entry only

Leaf Spring

Two points of contact.



Strengths

- No limit on mating pin length
- Less force required
- Suitable for dual entry
- Allows lower profile sockets

Weaknesses

- Higher cost
- Low retention force

Boxed and Polarised Products

Shrouded headers and sockets with a 'bump' allow for mating polarisation. Sockets may be plugged into a header in one orientation only.





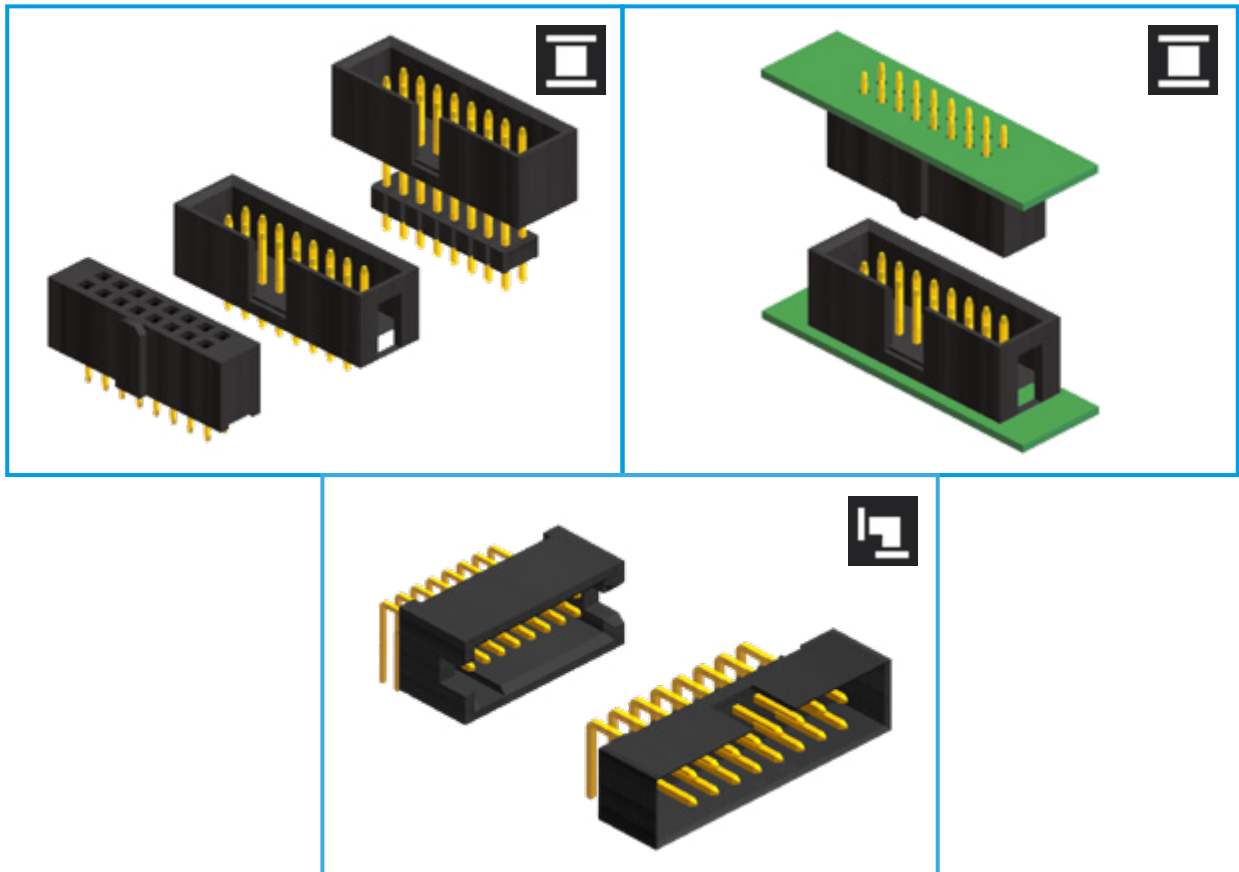



Pitch	Headers			Elevated Headers		Sockets		
	Through Hole		Surface Mount	Through Hole	Surface Mount	Through Hole		Surface Mount
	Vertical	Horizontal	Vertical	Vertical	Vertical	Vertical	Horizontal	Vertical
1.27mm	BB02-BE	BB02-BZ	BB02-BY	n/a	BB02-NN	BB02-CU	n/a	BB02-CM
2.00mm	BB02-FP	BB02-FQ	BB02-FY	BB02-FS	BB02-FW	BB02-RP		n/a
2.54mm	BB02-HQ	BB02-BQ	BB02-HR	BB02-HF	n/a	BB02-KW	BB02-KW	n/a

Board to Board

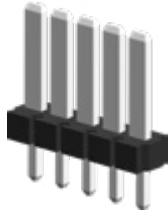

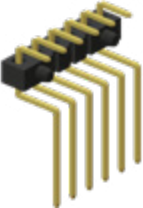
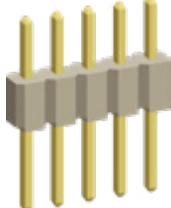
Custom PCB Connectors

GradConn offer a full custom connector service, from making minor changes on existing products to designing and manufacturing bespoke connectors. With affordable and flexible tooling our experienced engineers will guide you every step of the way, from helping design a solution specific to your needs, onto first draft drawings, then samples, approvals and production. Turnaround time on design to finish can take from a few days to a few weeks depending on complexity. Examples of special connectors which GradConn created working in partnership with customers include:

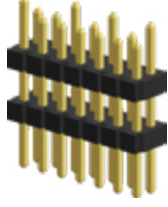
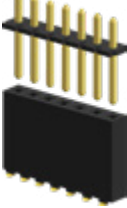
	<p>Pin Headers Custom Lead lengths –</p> <p>Drawings offer selectable lead lengths for mating & PCB terminating pins.</p>		<p>Non standard pin spacing pitch –</p> <p>This example is 2.54mm between pins and 3.5mm between rows, we can offer other variations upon request.</p>
	<p>Custom SMT lead lengths –</p> <p>Often selectable on GradConn drawings, if our parts don't fit the PCB footprint you require, contact us.</p>		<p>Bladed mating pins –</p> <p>Allows connection to tab receptacle type connectors but uses a 0.64mm square pin for PCB termination.</p>
	<p>Blanked holes on sockets and missing pins on headers –</p> <p>Offers inexpensive connector polarisation. Header and socket may only be mated together in the orientation. Useful in limited space applications where shrouded header solutions would not fit.</p>		<p>Alternative insulator materials –</p> <p>This example shows a receptacle normally produced in LCP, being available in Nylon 9T.</p>
	<p>PCB Header with pins bent in 3 places –</p> <p>Allows mating on a lower or higher plane</p>		<p>Different insulator colours –</p> <p>For example, Natural.</p>
	<p>Kinked Pins on through-hole parts –</p> <p>For PCB retention during soldering. GradConn offer kinked pins upon request.</p>		<p>Press fit custom special –</p> <p>This example was created for a specific custom PCB header design requirement.</p>
	<p>Angled pins on headers –</p> <p>Angled specific to your design.</p>		<p>Headers with selectively longer pins –</p> <p>Allows 'make first – break last' contact.</p>
	<p>PCB Header and receptacle insulators –</p> <p>Non standard sizes. For a modest tooling fee we can produce non-standard header insulators, sockets can be more tricky as sometimes a special contact design is required, however often a standard existing contact can be used.</p>		

PCB Mating Options Key

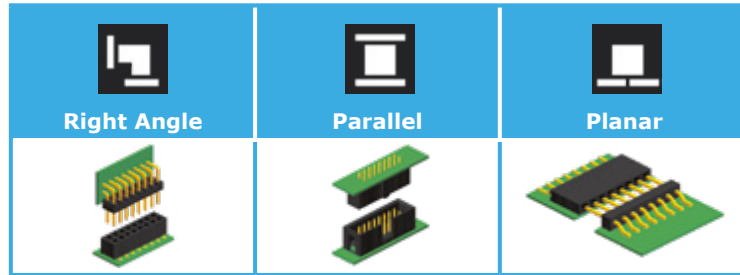

PCB Mating Options



1.00mm (.039") Pitch

Specification

Current Rating	1 Amp	Insulator Material	LCP	Header Pin Size	0.30mm sq. (.011")
Operating Temp.	-40°to +105°C			Plating	Gold Flash or Tin over 30-50µ" Nickel. For more plating options see page 8.
Contact Material	Brass or Phosphor Bronze	Flammability Rating	UL 94V-0		

Full specifications available at www.gradconn.com

Headers - Single In Line

Through Hole	Vertical		Horizontal	
	Surface Mount	Elevated	Through Hole	Surface Mount
BB02-YJ	BB02-YK	BB02-YR	BB02-YM	BB02-YN
BB02-YL				

Type	Range	Mount	Orientation	Stacking Profile	Ways	Peg
Header	BB02-YJ	Through Hole	Vertical	1.00mm	2-35	No
	BB02-YM	Through Hole	Horizontal	n/a	4-40	No
	BB02-YN	Surface Mount	Vertical	2.00mm	2-35	No
	BB02-YK	Surface Mount	Horizontal	n/a	2-35	No
Elevated Header	BB02-YL	Through Hole	Vertical	5.10mm - 20.00mm	2-40	No
	BB02-YR	Surface Mount	Vertical	2.50mm - 22.00mm	2-40	No

Sockets - Single In Line

Through Hole	Vertical		Horizontal	
	Surface Mount	Surface Mount	Surface Mount	Surface Mount
BB02-WD	BB02-WE	BB02-WF	BB02-WF	BB02-WF

Range	Mount	Orientation	Stacking Profile	Ways	Entry	Contact	Peg	Recommended Mating Length
BB02-WD	Through Hole	Vertical	2.10mm	2-35	Top	Leaf	No	1.50mm
BB02-WE	Through Hole	Vertical	2.25mm	2-35	Dual	Leaf	No	1.50 - 1.80mm
BB02-WF	Surface Mount	Horizontal	n/a	2-35	Side	Leaf	No	1.50mm

1.00mm Board to Board

1.00mm (.039") Pitch



Specification

Current Rating	1 Amp	Insulator Material	LCP	Header Pin Size	0.30mm sq. (.011")
Operating Temp.	-40°to +105°C			Plating	Gold Flash or Tin over 30-50μ" Nickel For more plating options see page 8.
Contact Material	Brass or Phosphor Bronze	Flammability Rating	UL 94V-0		

Full specifications available at www.gradconn.com

Headers & Sockets - Dual In Line

Vertical Headers		Horizontal Header		Vertical Socket
Through Hole	Surface Mount	Surface Mount		Surface Mount
BB02-YC	BB02-YF	BB02-YP		BB02-WA
BB02-YG	BB02-YH			

Type	Range	Mount	Orientation	Stacking Profile	Ways	Peg	Entry	Contact	Recommended Mating Length
Header	BB02-YC	Through Hole	Vertical	1.50mm	4-80	No	n/a	n/a	n/a
	BB02-YF	Surface Mount	Vertical	1.40mm - 1.90mm	4-80	No			
	BB02-YP	Surface Mount	Horizontal	n/a	4-30	No			
Elevated Header	BB02-YG	Through Hole	Vertical	2.40mm - 20.00mm	6-80	No	n/a	n/a	n/a
	BB02-YH	Surface Mount	Vertical	2.70mm - 22.00mm	4-80	No			
Socket	BB02-WA	Surface Mount	Vertical	2.25mm	4-70	Option	Dual	Leaf	1.50mm - 1.80mm

PCB Mating Option

0.80mm x 1.20mm (.031" x .047") Pitch



Specification

Current Rating	0.5 Amp	Insulator Material	LCP	Header Pin Size	0.30mm sq. (.011")
Operating Temp.	-40°to +105°C			Plating	Gold Flash or Tin over 30-50μ" Nickel For more plating options see page 8.
Contact Material	Phosphor Bronze	Flammability Rating	UL 94V-0		

Full specifications available at www.gradconn.com

Headers & Sockets - Dual In Line

Vertical		
SMT - Elevated Header	SMT - Header	SMT - Socket
BB02-AW	BB02-AY	BB02-AZ

Range	Mount	Orientation	Stacking Profile	Ways	Peg
BB02-AW	Surface Mount	Vertical	2.40mm - 12.80mm	6-100	Option
BB02-AY	Surface Mount	Vertical	4.75mm	6-100	Yes
BB02-AZ	Surface Mount	Vertical	1.50mm	6-100	Option

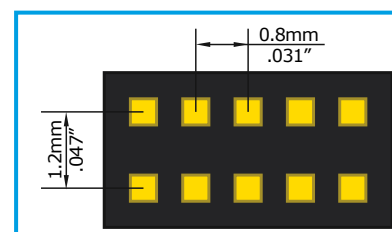



1.27mm (.050") Pitch

Specification

Current Rating	1 Amp	Insulator Material	PA6T or LCP	Header Pin Size	0.40mm (.0158") or SIL option 0.46mm (.018")
Operating Temp.	-40°to +105°C			Plating	Gold, Tin or selective over 30-50µ" Nickel. For more plating options see page 8.
Contact Material	Brass or Phosphor Bronze	Flammability Rating	UL 94V-0		

Full specifications available at www.gradconn.com

Headers - Single In Line

Vertical		Horizontal				U-Shaped
Through Hole	Surface Mount	Through Hole	Surface Mount	Through Hole	Surface Mount	Through Hole
BB02-BL BB02-NC	BB02-BM BB02-NA	BB02-NB BB02-NH	BB02-NS	BB02-5B	BB02-5B	BB02-5B
BB02-NM						

Type	Range	Mount	Orientation	Post Size	Stacking Profile	Ways	Peg
Header	BB02-NC	Through Hole	Vertical	0.40mm	1.00mm - 2.54mm	2-33	No
	BB02-NB	Through Hole	Horizontal		n/a	2-33	No
	BB02-NA	Surface Mount	Vertical		1.50mm - 3.00mm	3-33	No
	BB02-NS	Surface Mount	Horizontal		n/a	2-33	No
	BB02-5B	Through Hole	U-Shaped	n/a	1-50	No	
	BB02-BL	Through Hole	Vertical	0.46mm	1.70mm - 3.00mm	2-50	No
	BB02-NH	Through Hole	Horizontal		n/a	2-50	No
	BB02-BM	Surface Mount	Vertical		3.00mm	3-50	No
Elevated Header	BB02-NM	Through Hole	Vertical	0.46mm	2.00mm - 36.00mm	2-50	No

Best Price!

Best Price!

Best Price!

Best Price!

1.27mm Board to Board

Sockets - Single In Line

Vertical		Horizontal
Through Hole	Surface Mount	Through Hole
BB02-NU BB02-CE BB02-CT	BB02-CP BB02-NP	BB02-CT
BB02-CF	BB02-CY	

Range	Mount	Orientation	Mates with Post Size	Stacking Profile	Ways	Entry	Contact	Peg	Recommended Mating Length
BB02-CT	Through Hole	Vertical/Horizontal	0.40mm	4.30mm	2-40	Top	Leaf	No	4.00mm
BB02-CY	Surface Mount	Vertical		2.20mm	2-40	Dual	Leaf	No	1.50mm
BB02-CP	Surface Mount	Vertical		4.60mm	2-40	Dual	Leaf	No	3.50mm
BB02-NU	Through Hole	Vertical	0.46mm	3.40mm	2-33	Top	Leaf	No	1.80mm
BB02-CF	Through Hole	Vertical		4.60mm	2-50	Top	Tuning Fork	No	2.80mm
BB02-CE	Through Hole	Vertical		8.50mm	2-35	Top	Tuning Fork	No	4.00mm
BB02-NP	Surface Mount	Vertical		6.00mm	2-50	Dual	Leaf	No	4.00mm

Best Price!

Best Price!

1.27mm (.050") Pitch



Headers - Dual In Line

Vertical				Horizontal			
Through Hole		Surface Mount		Through Hole		Surface Mount	
BB02-BC		BB02-BS		BB02-BD		BB02-NE	
BB02-BE		BB02-BY					
BB02-BP		BB02-BK		BB02-BZ			
		BB02-NN					

Type	Range	Mount	Orientation	Stacking Profile	Ways	Boxed	Peg
Header	BB02-BC	Through Hole	Vertical	1.00mm - 3.00mm	4-66	No	No
	BB02-BE	Through Hole	Vertical	1.60mm	4-100	Yes	No
	BB02-BD	Through Hole	Horizontal	n/a	4-100	No	No
	BB02-BZ	Through Hole	Horizontal	n/a	6-100	Yes	No
	BB02-BS	Surface Mount	Vertical	1.50mm - 3.50mm	4-100	No	Option
	BB02-BY	Surface Mount	Vertical	1.60mm	10-100	Yes	Option
	BB02-NE	Surface Mount	Horizontal	n/a	6-66 4-66	No	Yes No
Elevated Header	BB02-BP	Through Hole	Vertical	2.00mm - 33.00mm	4-100	No	No
	BB02-BK	Surface Mount	Vertical	2.50mm - 29.00mm	4-100	No	Option
	BB02-NN	Surface Mount	Vertical	5.40mm - 15.00mm	10-80	Yes	Option

Best Price!

Best Price!

Best Price!

Sockets - Dual In Line

Vertical				Horizontal			
Through Hole		Surface Mount		Through Hole		Surface Mount	
BB02-CN		BB02-CQ BB02-CR BB02-CL		BB02-CW		BB02-CX	
BB02-CU (Polarised)		BB02-CM (Polarised)		BB02-CZ			

Range	Mount	Orientation	Stacking Profile	Ways	Entry	Contact	Peg	Recommended Mating Length
BB02-CN	Through Hole	Vertical	3.40mm - 4.40mm	6-100	Top	Leaf	No	3.00mm
BB02-CU	Through Hole	Vertical	4.40mm	8-100	Dual	Leaf	Option	3.00mm
BB02-CW	Through Hole	Horizontal	n/a	4-100	Side	Leaf	No	3.00mm
BB02-CZ	Through Hole	Horizontal	n/a	6-80	Side	Leaf	No	3.50mm
BB02-CQ	Surface Mount	Vertical	2.15mm	6-80	Dual	Leaf	Option	1.50mm
BB02-CR	Surface Mount	Vertical	3.60mm	6-100	Dual	Leaf	Option	3.00mm
BB02-CL	Surface Mount	Vertical	4.60mm	4-100	Dual	Leaf	Option	4.00mm
BB02-CM	Surface Mount	Vertical	4.60mm	8-100	Dual	Leaf	Option	4.00mm
BB02-CX	Surface Mount	Horizontal	n/a	6-80	Side	Leaf	No	3.50mm

Best Price!

Best Price!

Best Price!

1.27mm x 2.54mm (.050" x .100") Pitch



Specification

Current Rating	1 Amp	Insulator Material	PA6T	Header Pin Size	0.46mm (.018")
Operating Temp.	-40°to +105°C			Plating	Gold, Flash or Tin over 30-50µ" Nickel. For more plating options see page 8.
Contact Material	Brass	Flammability Rating	UL 94V-0		

Full specifications available at www.gradconn.com

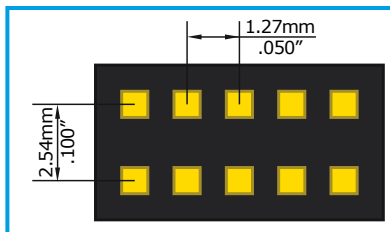

Headers - Dual In Line

	Vertical		Horizontal
	Through Hole	Surface Mount	Through Hole
BB02-DA		BB02-DF	BB02-DE
BB02-DG			

Type	Range	Mount	Orientation	Stacking Profile	Ways	Peg
Header	BB02-DA	Through Hole	Vertical	1.70mm - 3.00mm	6-80	No
	BB02-DE	Through Hole	Horizontal	n/a	6-80	No
	BB02-DF	Surface Mount	Vertical	3.81mm	6-80	No
Elevated Header	BB02-DG	Through Hole	Vertical	5.10mm - 40.00mm	6-80	No

1.27 x 2.54mm Board to Board

Sockets - Dual In Line

	Vertical	
	Through Hole	Surface Mount
BB02-EA		BB02-EB
BB02-EC		

Range	Mount	Orientation	Stacking Profile	Ways	Entry	Contact	Peg	Recommended Mating Length
BB02-EA	Through Hole	Vertical	4.60mm	6-100	Top	Tuning Fork	No	2.50mm
BB02-EC	Through Hole	Vertical	8.50mm	6-70	Top	Tuning Fork	No	4.50mm
BB02-EB	Surface Mount	Vertical	6.00mm	6-80	Dual	Leaf	Option	4.00mm

PCB Mating Options Key

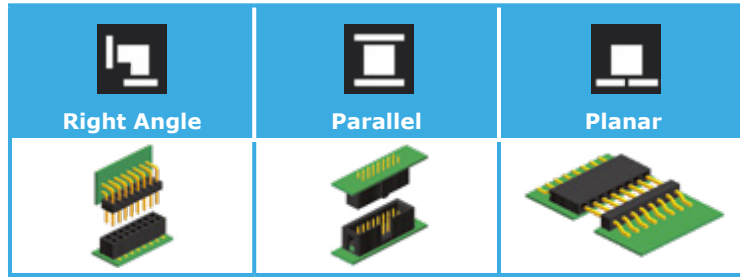

PCB Mating Options



2.00mm (.079") Pitch

Specification

Current Rating	2 Amp	Insulator Material	PA6T, PA9T, LCP	Header Pin Size	0.50mm (.0197")
Operating Temp.	-40°to +105°C			Plating	Gold, Tin or selective over 30-50µ" Nickel. For more plating options see page 8.
Contact Material	Brass or Phosphor Bronze	Flammability Rating	UL 94V-0		

Full specifications available at www.gradconn.com

Headers - Single In Line

Vertical		Horizontal		U Shaped
Through Hole	Surface Mount	Through Hole	Surface Mount	Through Hole
BB02-FB	BB02-FL	BB02-FB	BB02-FK	BB02-1F
BB02-RM	BB02-RT			

Type	Range	Mount	Orientation	Stacking Profile	Ways	Peg
Header	BB02-FB	Through Hole	Vertical/Horizontal	1.50mm - 2.00mm	2-40	No
	BB02-FL	Surface Mount	Vertical	3.80mm	2-40	No
	BB02-FK	Surface Mount	Horizontal	n/a	2-40	No
	BB02-1F	Through Hole	U Shaped	n/a	2-40	No
Elevated Header	BB02-RM	Through Hole	Vertical	3.00mm - 38.20mm	2-40	No
	BB02-RT	Surface Mount	Vertical	4.30mm - 36.00mm	2-40	No

Best Price!

Sockets - Dual In Line

Vertical		Horizontal	
Through Hole	Surface Mount	Through Hole	Surface Mount
BB02-GD BB02-RK	BB02-GS BB02-RS	BB02-GD BB02-RK	BB02-RW

Range	Mount	Orientation	Stacking Profile	Ways	Entry	Contact	Peg	Recommended Mating Length
BB02-GD	Through Hole	Vertical/Horizontal	4.30mm	2-40	Top	Leaf Style	No	4.00mm
BB02-RK	Through Hole	Vertical/Horizontal	6.35mm	2-40	Top	Tuning Fork	No	4.00mm
BB02-RS	Surface Mount	Vertical	2.35mm	2-40	Dual	Leaf Style	Option	1.60mm
BB02-GS	Surface Mount	Vertical	4.50mm	2-40	Dual	Leaf Style	No	4.00mm
BB02-RW	Surface Mount	Horizontal	n/a	2-40	n/a	Tuning Fork	No	3.20mm

Best Price!

Best Price!



2.00mm (.079") Pitch

Headers - Dual In Line

Vertical		Horizontal		U Shaped
Through Hole	Surface Mount	Through Hole	Surface Mount	Through Hole
BB02-FA BB02-4F* BB02-FD BB02-FG	BB02-FE	BB02-FD	BB02-RH	BB02-2F
BB02-FP	BB02-FY	BB02-FG		
BB02-RN	BB02-FU	BB02-FQ		
BB02-FS	BB02-FW	BB02-FZ		

Type	Range	Mount	Orientation	Stacking Profile	Ways	Boxed	Peg
Header	BB02-FA	Through Hole	Vertical	1.00mm	4-80	No	No
	BB02-4F*	Through Hole	Vertical	1.50mm - 2.00mm	4-60	No	No
	BB02-FD	Through Hole	Vertical/Horizontal	1.50mm - 2.00mm	4-80	No	No
	BB02-FP	Through Hole	Vertical	1.70mm	6-50	Yes	No
	BB02-FG	Through Hole	Vertical/Horizontal	4.00mm	4-80	No	No
	BB02-FQ	Through Hole	Horizontal	n/a	6-50	Yes	No
	BB02-2F	Through Hole	U Shaped	n/a	2-80	No	No
	BB02-FE	Surface Mount	Vertical	1.80mm - 3.45mm	4-80	No	Option
	BB02-FY	Surface Mount	Vertical	1.70mm	8-50	Yes	Option
BB02-RH	Surface Mount	Horizontal	n/a	6-80	No	Option	
Elevated Header	BB02-RN	Through Hole	Vertical	4.00mm - 38.20mm	4-80	No	No
	BB02-FS	Through Hole	Vertical	3.70mm - 27.70mm	8-50	Yes	No
	BB02-FU	Surface Mount	Vertical	4.80mm - 36.00mm	6-80	No	Option
	BB02-FW	Surface Mount	Vertical	4.30mm - 21.80mm	8-50	Yes	Option
	BB02-FZ	Through Hole	Horizontal	n/a	4-80	No	No

Best Price!

Best Price!

2.00mm Board to Board

* Compatible for surface mount process. Insulator standoffs allow solder paste to sit beneath.

Headers - Triple In Line

Vertical	Horizontal
Through Hole	Through Hole
BB02-RR	BB02-RR

Range	Mount	Orientation	Stacking Profile	Ways	Peg
BB02-RR	Through Hole	Vertical/Horizontal	2.00mm	9-120	No

Headers - Quad In Line

Vertical	Horizontal
Through Hole	Through Hole
BB02-FM	BB02-FM

Range	Mount	Orientation	Stacking Profile	Ways	Peg
BB02-FM	Through Hole	Vertical/Horizontal	1.50mm	24-120	No



2.00mm (.079") Pitch

Sockets - Dual In Line

Vertical		Horizontal	
Through Hole	Surface Mount	Through Hole	Surface Mount
BB02-GH BB02-RL BB02-RP (Polarised)	BB02-GQ BB02-GZ BB02-RG	BB02-RL BB02-GL	BB02-GY
BB02-GP	BB02-RJ	BB02-GK	BB02-RX

Type	Range	Mount	Orientation	Stacking Profile	Ways	Entry	Contact	Peg	Recommended Mating Length
Socket	BB02-RP	Through Hole	Vertical	4.00mm	6-80	Top	Leaf	No	4.00mm
	BB02-GH	Through Hole	Vertical	4.00mm - 4.30mm	4-80	Top	Leaf	No	3.00 - 3.80mm
	BB02-GM	Through Hole	Vertical	4.30mm	6-80	Dual	Leaf	No	4.00mm
	BB02-RL	Through Hole	Vertical/Horizontal	6.35mm	4-80	Top	Tuning Fork	No	4.00mm
	BB02-GK	Through Hole	Horizontal	n/a	4-50	Side	Leaf	No	4.00mm
	BB02-GL	Through Hole	Horizontal	n/a	6-80	Side	Leaf	No	4.00mm
	BB02-RG	Surface Mount	Vertical	2.20mm	4-80	Dual	Leaf	Option	1.50mm
	BB02-GZ	Surface Mount	Vertical	2.80mm	6-70	Dual	Leaf	Option	2.00mm
	BB02-GQ	Surface Mount	Vertical	4.30mm - 4.60mm	6-80	Dual	Leaf	Option	3.00mm
	BB02-RJ	Surface Mount	Vertical	6.35mm	4-80	Top	Tuning Fork	Option	4.00mm
	BB02-GY	Surface Mount	Horizontal	n/a	4-50	Side	Leaf	No	4.00mm
	BB02-RX	Surface Mount	Horizontal	n/a	4-80	Side	Tuning Fork	No	3.20mm
Elevated Socket	BB02-GP	Through Hole	Vertical	8.25mm - 18.55mm	6-80	Top	Tuning Fork	No	4.00mm

Best Price!

Best Price!

Best Price!

Best Price!

Sockets - Triple In Line

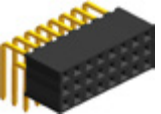
Vertical		Horizontal	
Through Hole		Through Hole	
BB02-RQ		BB02-RQ	

Range	Mount	Orientation	Stacking Profile	Ways	Entry	Contact	Peg	Recommended Mating Length
BB02-RQ	Through Hole	Vertical/Horizontal	6.35mm	9-120	Top	Tuning Fork	No	4.00mm

Sockets - Quad In Line

Vertical	
Socket	Elevated Socket
BB02-GA	BB02-GW

Type	Range	Mount	Orientation	Stacking Profile	Ways	Entry	Contact	Peg	Recommended Mating Length
Socket	BB02-GA	Through Hole	Vertical	6.35mm	8-120	Top	Tuning Fork	No	3.50mm - 4.00mm
Elevated Socket	BB02-GW	Through Hole	Vertical	7.85mm - 14.39mm	16-120	Top	Tuning Fork	No	3.50mm - 4.00mm



2.54mm (.100") Pitch

Headers - Single In Line

Vertical		Horizontal				U-Shaped
Through Hole	Surface Mount	Through Hole	Surface Mount	Through Hole	Surface Mount	Through Hole
BB02-HC BB02-TP* BB02-HA BB02-TC*	BB02-HY	BB02-HA	BB02-HG BB02-HH	BB02-1H		
BB02-HD	BB02-TJ	BB02-TK				

Type	Range	Mount	Orientation	Stacking Profile	Ways	Peg
Header	BB02-HC	Through Hole	Vertical	1.50mm	2-40	No
	BB02-TP*	Through Hole	Vertical	1.50mm	2-40	No
	BB02-HA	Through Hole	Vertical/Horizontal	2.54mm	2-40	No
	BB02-TC*	Through Hole	Vertical	2.54mm	2-40	No
	BB02-1H	Through Hole	U Shaped	2.54mm	2-40	No
	BB02-HY	Surface Mount	Vertical	2.91mm - 4.16mm	2-40	Yes
	BB02-HG	Surface Mount	Horizontal	n/a	2-30	Option
	BB02-HH	Surface Mount	Horizontal	n/a	2-40	No
Elevated Header	BB02-HD	Through Hole	Vertical	5.08mm - 41.00mm	1-40	No
	BB02-TJ	Surface Mount	Vertical	6.10mm - 40.00mm	2-40	No
	BB02-TK	Through Hole	Horizontal	n/a	2-40	No

Best Price!

Best Price!

* Compatible for surface mount process. Insulator standoffs allow solder paste to sit beneath.

Sockets - Single In Line

Vertical		Horizontal			
Through Hole	Surface Mount	Through Hole	Surface Mount	Through Hole	Surface Mount
BB02-JB BB02-JE BB02-JF BB02-JT	BB02-JG BB02-KR	BB02-JB BB02-JE	BB02-JR	BB02-JS	BB02-JU
BB02-JL		BB02-JJ			
BB02-JC					

Type	Range	Mount	Orientation	Stacking Profile	Ways	Entry	Contact	Peg	Recommended Mating Length
Socket	BB02-JT	Through Hole	Vertical	3.50mm	2-40	Top	Leaf Style	No	2.50mm
	BB02-JL	Through Hole	Vertical	5.00mm	2-40	Dual	Leaf Style	No	4.50mm
	BB02-JE	Through Hole	Vertical/Horizontal	5.00mm	2-40	Top	Leaf Style	No	4.50mm
	BB02-JF	Through Hole	Vertical	7.10mm	2-40	Top	Leaf Style	No	4.50mm
	BB02-JB	Through Hole	Vertical/Horizontal	8.50mm	2-40	Top	Tuning fork	No	6.00mm
	BB02-JJ	Through Hole	Horizontal	n/a	2-40	Side	Leaf Style	No	4.50mm
	BB02-JG	Surface Mount	Vertical	7.50mm	2-40	Dual	Leaf Style	Yes	4.00mm
	BB02-KR	Surface Mount	Vertical	5.00mm	2-40	Dual	Leaf Style	Yes	4.50mm
	BB02-JR	Surface Mount	Horizontal	n/a	2-40	Side	Leaf Style	No	4.50mm
	BB02-JS	Surface Mount	Horizontal	n/a	2-30	Side	Tuning fork	No	6.00mm
BB02-JU	Surface Mount	Horizontal	n/a	2-20	Side	Leaf Style	No	4.50mm	
Elevated Socket	BB02-JC	Through Hole	Vertical	11.05mm - 18.67mm	2-40	Top	Tuning fork	No	6.00mm

Best Price!

Best Price!

Best Price!

2.54mm Board to Board

2.54mm (.100") Pitch



Specification

Current Rating	3 Amp	Insulator Material	PA6T, or LCP	Header Pin Size	0.64mm (.025")
Operating Temp.	-40°to +105°C			Plating	Gold or Tin over 30-50μ" Nickel. For more plating options see page 8.
Contact Material	Brass or Phosphor Bronze	Flammability Rating	UL 94V-0		

Full specifications available at www.gradconn.com

Headers - Dual In Line

Vertical				Horizontal				U Shaped	
Through Hole		Surface Mount		Through Hole		Surface Mount		Through Hole	
BB02-HE BB02-HJ BB02-TF		BB02-HP		BB02-HE		BB02-TD BB02-TH		BB02-2H	
BB02-HQ		BB02-HR							
BB02-HF		BB02-HU		BB02-HQ					
BB02-TG									

Type	Range	Mount	Orientation	Stacking Profile	Ways	Boxed	Peg
Header	BB02-HJ	Through Hole	Vertical	1.50mm	4-80	No	No
	BB02-HE	Through Hole	Vertical/Horizontal	2.54mm	4-80	No	No
	BB02-TF	Through Hole	Vertical	2.54mm	4-60	No	No
	BB02-HQ	Through Hole	Vertical/Horizontal	2.70mm	6-64	Yes	No
	BB02-2H	Through Hole	U Shaped	5.00mm	2-80	No	No
	BB02-HP	Surface Mount	Vertical	2.60mm - 3.81mm	4-80	No	Option
	BB02-HR	Surface Mount	Vertical	3.80mm	6-64	Yes	No
	BB02-TD BB02-TH	Surface Mount	Horizontal	n/a	6-60	No	Option
Elevated Header	BB02-HF	Through Hole	Vertical	5.20mm - 28.70mm	6-64	Yes	No
	BB02-TG	Through Hole	Vertical	5.10mm - 41.00mm	4-80	No	No
	BB02-HU	Surface Mount	Vertical	6.10mm - 41.00mm	6-80	No	Option

Best Price!

Best Price!

Best Price!

Headers - Triple In Line









Vertical				Horizontal	
Standard - TH		Elevated - TH		Through Hole	
BB02-HL		BB02-TE		BB02-HL	

Type	Range	Mount	Orientation	Stacking Profile	Ways	Peg
Header	BB02-HL	Through Hole	Vertical/Horizontal	2.54mm	9-120	No
Elevated Header	BB02-TE	Through Hole	Vertical	5.10mm - 41.00mm	9-120	No

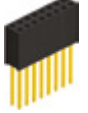

2.54mm (.100") Pitch

Sockets - Dual In Line

Vertical		Horizontal	
Through Hole	Surface Mount	Through Hole	Surface Mount
BB02-KA BB02-KF BB02-KG BB02-KH BB02-KK BB02-KW BB02-KZ 	BB02-KS BB02-KU BB02-KY 	BB02-KA BB02-KW (Polarised) 	BB02-KQ 
BB02-KM BB02-LD 		BB02-JM 	BB02-LE 
BB02-KT 			
BB02-KD 			

Type	Range	Mount	Orientation	Stacking Profile	Ways	Entry	Contact	Peg	Recommended Mating Length
Socket	BB02-KZ	Through Hole	Vertical	3.50mm	4-80	Top	Leaf Style	No	2.00mm
	BB02-KF	Through Hole	Vertical	5.00mm	4-80	Top	Leaf Style	No	4.50mm
	BB02-KM	Through Hole	Vertical	5.00mm	4-80	Dual	Leaf Style	No	4.50mm
	BB02-KG	Through Hole	Vertical	6.80mm	4-60	Top	Leaf Style	No	6.00mm
	BB02-KH	Through Hole	Vertical	7.10mm	4-80	Top	Leaf Style	No	6.00mm
	BB02-LD	Through Hole	Vertical	7.60mm	4-80	Dual	Leaf Style	No	6.00mm
	BB02-KK	Through Hole	Vertical	8.50mm	4-80	Top	Leaf Style	No	6.00mm
	BB02-KA	Through Hole	Vertical/Horizontal	8.50mm	4-80	Top	Tuning fork	No	6.00mm
	BB02-KW	Through Hole	Vertical/Horizontal	8.50mm	6-72	Top	Tuning fork	No	6.00mm
	BB02-KT	Through Hole	Vertical	11.00mm	4-80	Top	Tuning fork	No	4.50mm
	BB02-JM	Through Hole	Horizontal	n/a	4-80	Side	Leaf Style	No	4.50mm
	BB02-KY	Surface Mount	Vertical	3.65mm	4-80	Dual	Leaf Style	Option	2.00mm
	BB02-KS	Surface Mount	Vertical	5.00mm	4-80	Dual	Leaf Style	Option	4.50mm
	BB02-KU	Surface Mount	Vertical	7.50mm	6-80	Dual	Leaf Style	Option	4.50mm
BB02-LE	Surface Mount	Horizontal	n/a	4-80	Side	Tuning fork	No	6.00mm	
BB02-KQ	Surface Mount	Horizontal	n/a	4-80	Side	Leaf Style	No	4.50mm	
Elevated Socket	BB02-KD	Through Hole	Vertical	8.50mm - 16.13mm	4-80	Top	Tuning Fork	No	6.00mm



2.54mm Board to Board

Best Price!

Best Price!

Best Price!

Sockets - Triple In Line

Vertical - Through Hole	
Standard	Elevated
BB02-LA 	BB02-LB 

Type	Range	Mount	Orientation	Stacking Profile	Ways	Entry	Contact	Peg	Recommended Mating Length
Socket	BB02-LA	Through Hole	Vertical	8.50mm	9-120	Top	Tuning Fork	No	6.00mm
Elevated Socket	BB02-LB	Through Hole	Vertical	11.05mm - 18.67mm	9-120	Top	Tuning Fork	No	6.00mm

3.96mm (.156") Pitch



Specification

Current Rating	7.9 Amp	Insulator Material	LCP	Header Pin Size	1.14mm (.0449")
Operating Temp.	-40° to +105°C			Flammability Rating	UL 94V-0
Contact Material	Headers - Brass Sockets - Phosphor Bronze				

Full specifications available at www.gradconn.com

Headers - Single In Line

		Vertical		Horizontal	
		Through Hole	Surface Mount	Through Hole	
BB02-UG		BB02-UK		BB02-UH	
BB02-UJ					

Type	Range	Mount	Orientation	Stacking Profile	Ways	Peg
Header	BB02-UG	Through Hole	Vertical	3.18mm	2-24	No
	BB02-UH	Through Hole	Horizontal	n/a	2-24	No
	BB02-UK	Surface Mount	Vertical	5.73mm	2-24	No
Elevated Header	BB02-UJ	Through Hole	Vertical	6.36mm - 19.80mm	2-24	No

Sockets - Single In Line

		Vertical	
		Through Hole	Surface Mount
BB02-US		BB02-UT	

Range	Mount	Orientation	Stacking Profile	Ways	Entry	Contact	Peg	Recommended Mating Length
BB02-US	Through Hole	Vertical	8.89mm	2-24	Top	3 Points	No	5.00mm
BB02-UT	Surface Mount	Vertical	9.35mm	2-24	Dual	3 Points	No	5.00mm

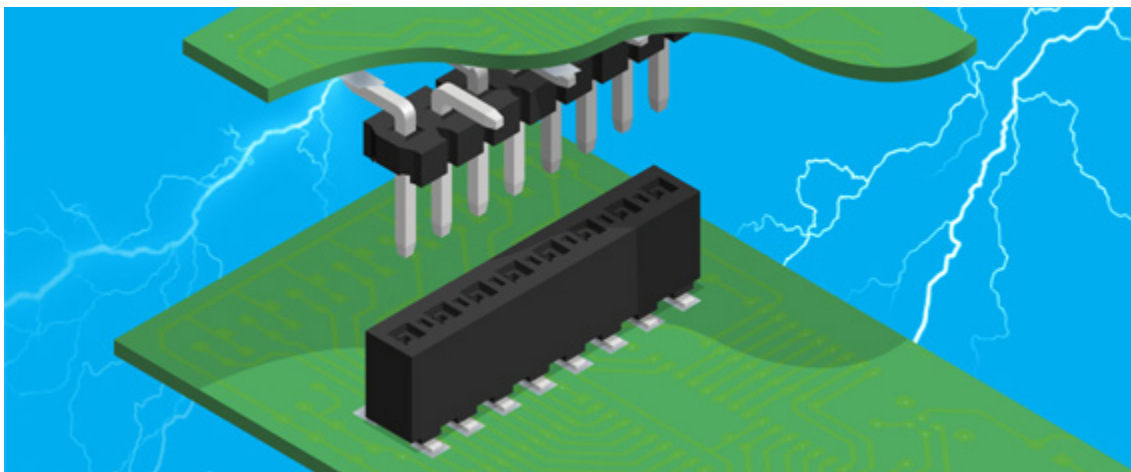



5.08mm (.200") Pitch

Specification

Current Rating	7.9 Amp	Insulator Material	LCP	Header Pin Size	1.14mm (.0449")
Operating Temp.	-40° to +105°C			Plating	Matt Tin over 30-50µ" Nickel. For more plating options see page 8.
Contact Material	Headers - Brass Sockets - Phosphor Bronze	Flammability Rating	UL 94V-0		

Full specifications available at www.gradconn.com

Headers - Single In Line

		Vertical		Horizontal	
		Through Hole	Surface Mount	Through Hole	
BB02-VA		BB02-VD		BB02-VB	
BB02-VC					

Type	Range	Mount	Orientation	Stacking Profile	Ways	Peg
Header	BB02-VA	Through Hole	Vertical	2.54mm	2-20	No
	BB02-VB	Through Hole	Horizontal	n/a	2-20	No
	BB02-VD	Surface Mount	Vertical	4.00mm	2-20	No
Elevated Header	BB02-VC	Through Hole	Vertical	5.00mm - 29.00mm	2-20	No

Sockets - Single In Line

		Vertical	
		Through Hole	Surface Mount
BB02-VM		BB02-VN	

Range	Mount	Orientation	Stacking Profile	Ways	Entry	Contact	Peg	Recommended Mating Length
BB02-VM	Through Hole	Vertical	8.89mm	2-24	Top	3 Points	No	5.00mm
BB02-VN	Surface Mount	Vertical	9.35mm	2-24	Dual	3 Points	No	5.00mm

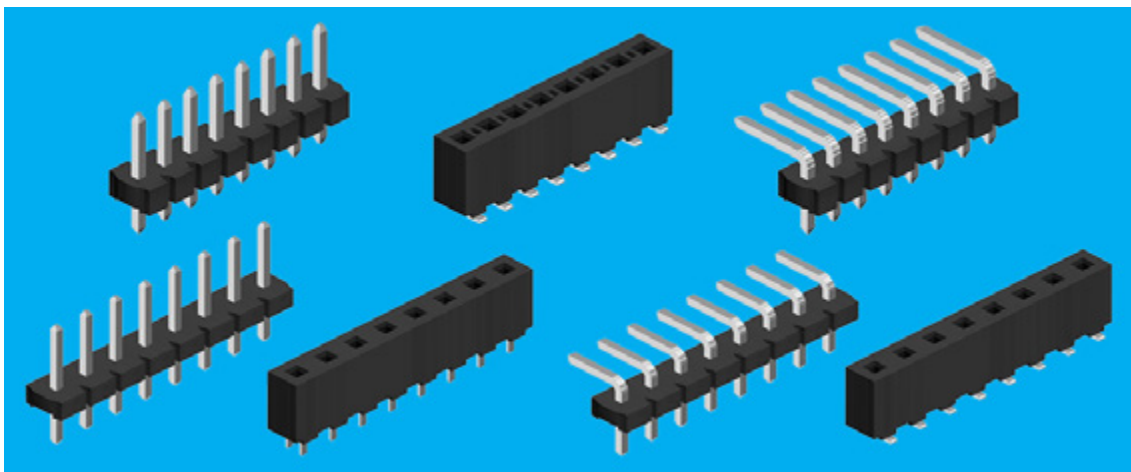

5.08mm Board to Board

Planar Mating for LED Lighting Applications

Pluggable Solutions

U-Shaped Direct to PCB

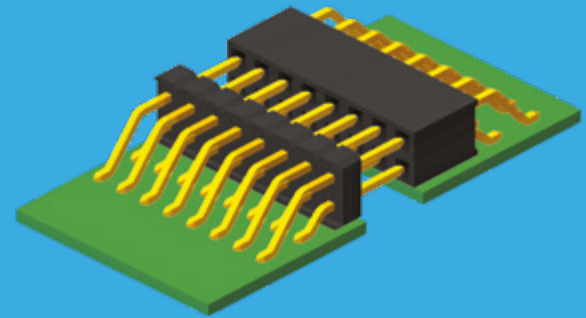
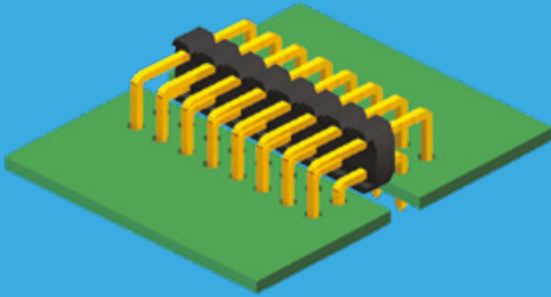

Perfect Height

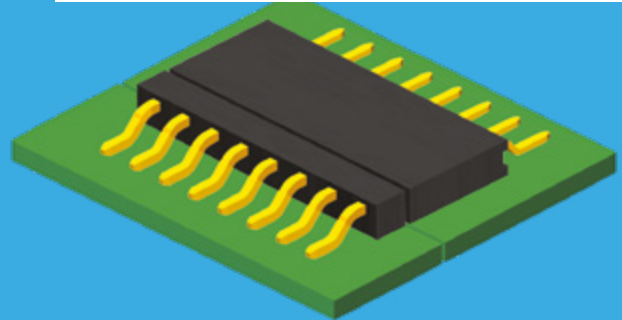

U-Shaped with Vertical Sockets

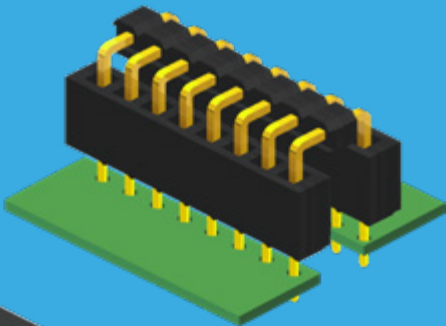

Many Options Available

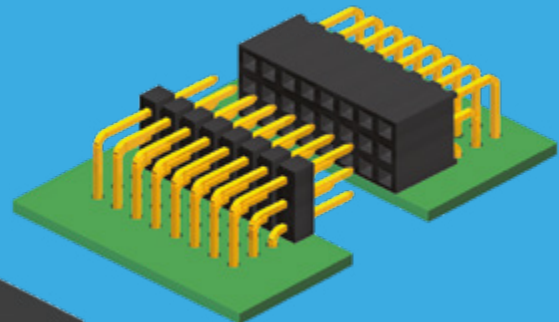

View GradConn's online guide to horizontal PCB mating. With images, video and a selection of perfect height mating connectors you will find the right design combination fast. More details on page 7

www.GradConn.com/Products/BoardToBoard/CoPlanarConnectors

Online Board to Board Search Filtering

Filter Options (Showing 176 products) [Reset Search](#)

Pitch Range	Mount Type	Orientation	Number of Rows	Gender	Elevated?
0.8 x 1.2mm (.031"x.047")	Surface mount	Right angle	Single	Socket (Female)	No
1.00mm (.039")	Thru hole	Straight	Dual	Header (Male)	Yes
1.27mm (.050")	Thru hole SMT compatible	U shaped	Triple	Locating Peg?	Polarised?
1.27x2.54mm (.050"x.100")	Accessory Type		Quad	With	No
2.00mm (.079")	Shunt			Without	Yes
2.54mm (.100")					
3.96mm (.156")					
5.08mm (.200")					



GradConn's online search filtering facility is fast and easy to use. Choosing from multiple attributes allows you to find your precise requirement in a few clicks. Once you've selected the parts you seek, find drawings, product specifications, 3D models and easily specify mating halves.

Filter Options (Showing 9 products) [Reset Search](#)

Pitch Range	Mount Type	Orientation	Number of Rows	Gender	Elevated?
0.8 x 1.2mm (.031"x.047")	Surface mount	Right angle	Single	Socket (Female)	No
1.00mm (.039")	Thru hole	Straight	Dual	Header (Male)	Yes
1.27mm (.050")	Thru hole SMT compatible	U shaped	Triple	Locating Peg?	Polarised?
1.27x2.54mm (.050"x.100")			Quad	With	No
2.00mm (.079")				Without	Yes
2.54mm (.100")					
3.96mm (.156")					
5.08mm (.200")					

Pegs for Alignment Critical Applications

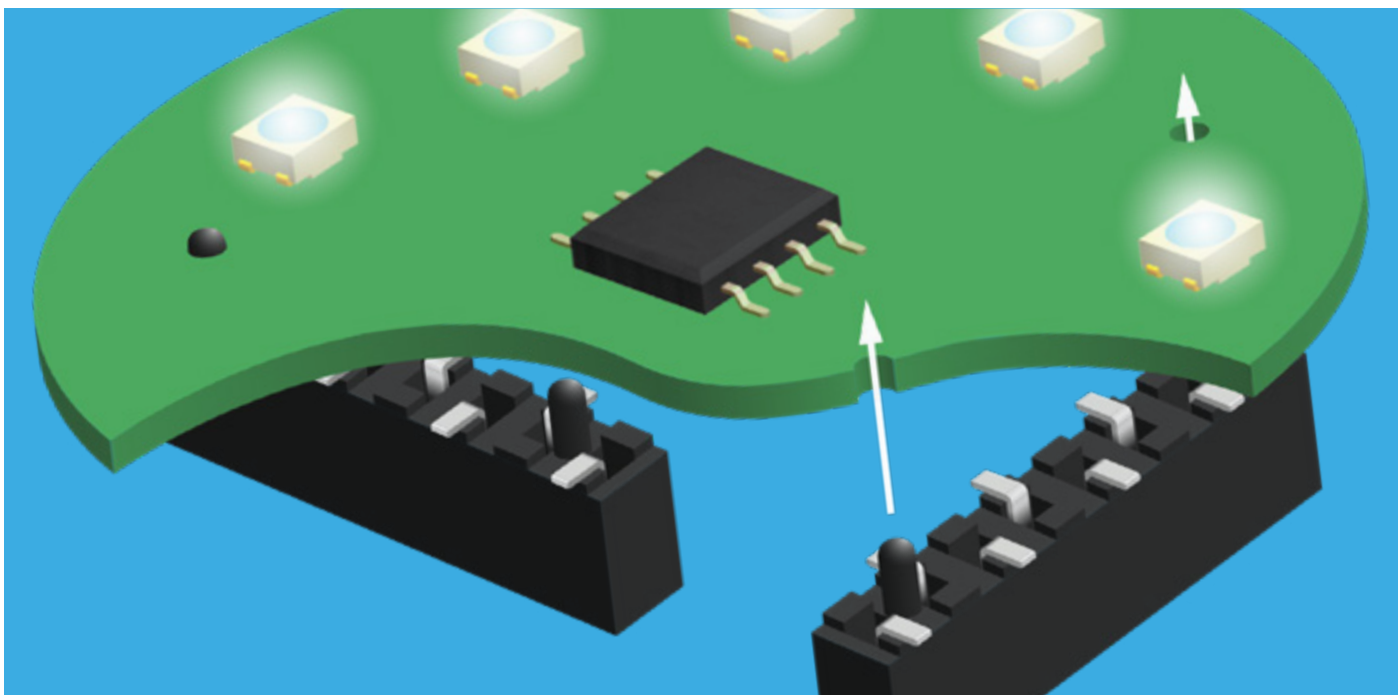

GradConn offers a range of SMT board to board connectors with locating pegs. Lead-free alloys are often found to spread less than traditional tin lead solders, pad edges can be left exposed and lower wetting means reduced realignment is possible during reflow. Initial placement accuracy is critical. Pegs allow connectors to be placed perfectly onto the PCB, allowing matching alignment between mating halves.

Connector mating can be critical in many applications, for example in circular LED PCB designs where PCB's are encased in a molded case, misalignment of connectors has implications for final product builds.

Wire to Board Connectors & Cable Assemblies

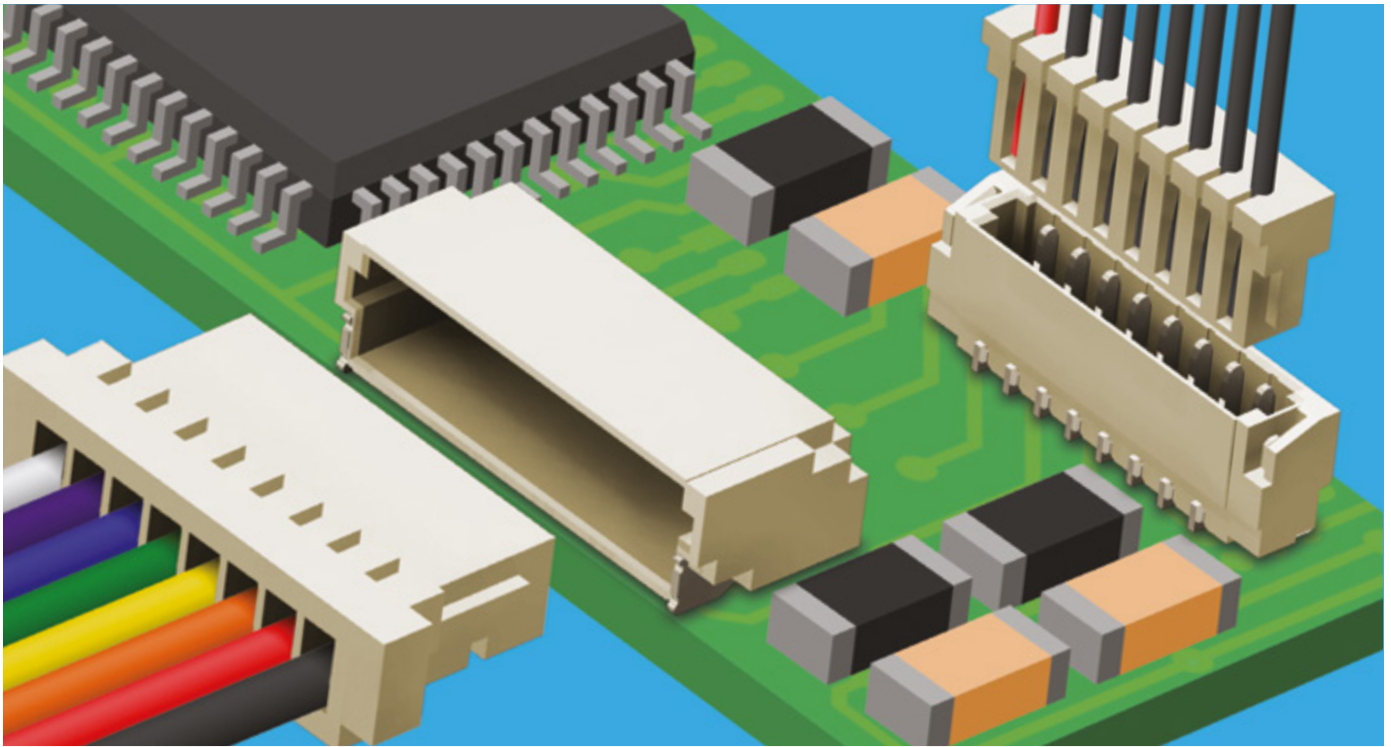

Suitable for any application where space is at a premium, GradConn's fine-pitch wire-to-board range offers tiny PCB footprints and low profile mounted heights.

Vertical and horizontal PCB headers in single in line orientation are shrouded and polarized to avoid mismatching. 1.20mm pitch (.047") products allow mating termination in tight spaces allowing ease of use for operators.

A combination of vertical PCB header and cable assembly has a tiny footprint with a mating height of only 3.95mm (.155")*. Where height above the PCB is critical, right angle headers offer a 1.45mm (.057") mated height**.

Rated currents range from are 0.5A (0.8mm pitch) to 1.5A (1.2mm pitch 28AWG).

Cable assemblies are available to suit whichever design you choose, see examples on page 28.

Cable Sockets and PCB headers are available in a selection of colours for polarisation purposes.

* 0.80mm pitch example ** 1.20mm pitch example

Specifications

Pitch	0.80mm	1.00mm	1.20mm
Number of Contacts	2 to 22*	2 to 20	2 to 6
Current Rating	0.7A AC/DC (AWG 32)	1.0A AC/DC (AWG 28)	1.5A AC/DC (AWG 28) 1.0A AC/DC (AWG 30)
Voltage Rating	30V AC/DC	50V AC/DC	
Insulator Resistance	100 MΩ minimum		
Dielectric Withstanding	200V AC/minute	500V AC/minute	
Operating Temperature	-25°C to +85°C		
Contact Resistance	20 mΩ maximum		
Insulator Material	Nylon 6T, UL 94V-0		
Header Plating	Matte tin over Nickel	Bright tin over Nickel	Gold Flash over Nickel

Full specifications available at www.gradconn.com

* Header only

0.80mm (.031") Pitch

PCB Headers & Cable Assemblies

Vertical	WB06-AA Unmated profile of 2.70mm (.106")	Assembly 	Options	
	Horizontal		WB06-AB Unmated profile of 1.70mm (.067")	Wire Gauge AWG32
WH0046 (example part number)		Min. Cable Length 30mm		

Mating Profiles & PCB Layouts

Vertical		Horizontal		Vertical	WB06-AA Recommended PCB Layout (mm)	
Horizontal				Horizontal	WB06-AB Recommended PCB Layout (mm)	

1.00mm (.039") Pitch

PCB Headers & Cable Assemblies

Vertical	WB06-BA Unmated profile of 4.25mm (.167")	Assembly 	Options	
	Horizontal		WB06-BB Unmated profile of 2.90mm (.114")	Wire Gauge AWG28 AWG30 AWG32
WH0058 (example part number)		Min. Cable Length 40mm		

Mating Profiles & PCB Layouts

Vertical		Horizontal		Vertical	WB06-BA Recommended PCB Layout (mm)	
Horizontal				Horizontal	WB06-BB Recommended PCB Layout (mm)	

1.20mm (.047") Pitch

PCB Headers & Cable Assemblies

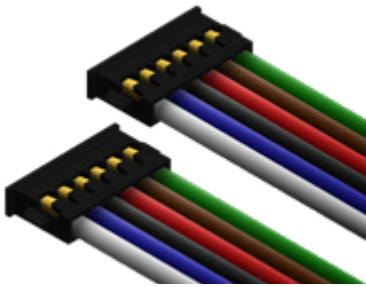
Horizontal	WB06-DA (Unmated profile of 1.45mm)		Assembly		Options	
			WH0070 (example part number)		Wire Gauge	AWG28 AWG30
					Cable Colours	Black, White Grey, Brown Red, Orange Yellow, Green Blue, Purple
					Min. Cable Length	40mm

Mating Profiles & PCB Layouts

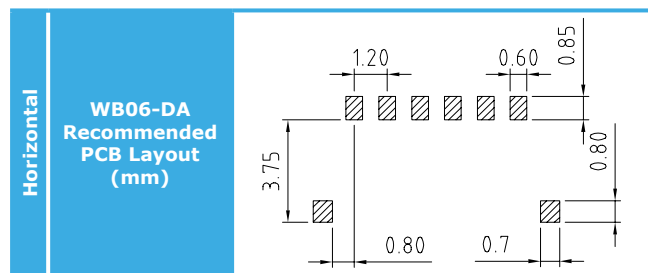
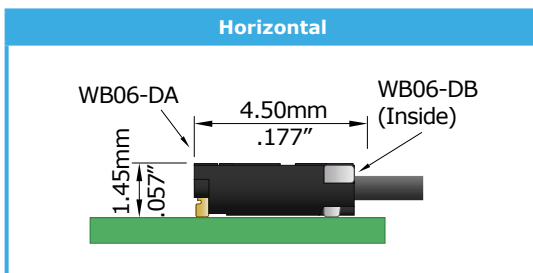

Online Wire-to-Board Cable Builder

GradConn's wire to board assembly builder allows you to build a custom cable assembly, it's a simple and quick way to request the perfect cable to suit your design. The builder allows you to specify simple point to point cables and more complex types such as breakout cables. In addition to using GradConn connectors, you may also specify competitor part numbers allowing thousands of variations. The builder allows you to specify connector pin layouts and colour cable identification for each contact.

Choose from options including: Connector type, number of connector contacts, cable length and diameter. Specify extra options - heat shrink, cable marking and jacketing.

10-way GradConn to 10-way GradConn



10-way GradConn to 2x5-way GradConn

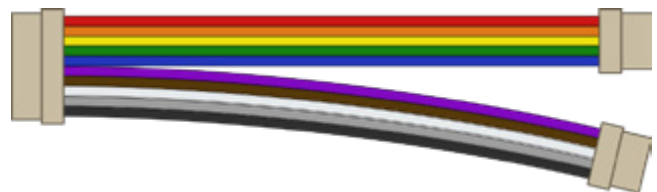

15-way GradConn to 15-way Competitor Connector



22-way GradConn to Micro D-Sub

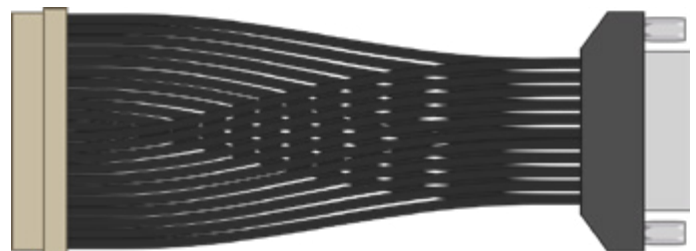

www.GradConn.com/Products/WireToBoard/AssemblyBuilder

Coaxial Cable Assemblies

GradConn offer a wide variety of coaxial cable assemblies, with particular strength in micro coaxial cables for wireless markets, such as GSM, GPS, Wireless LAN (WLAN), Wi-Fi, Zigbee Z-Wave, EnOcean and Bluetooth.

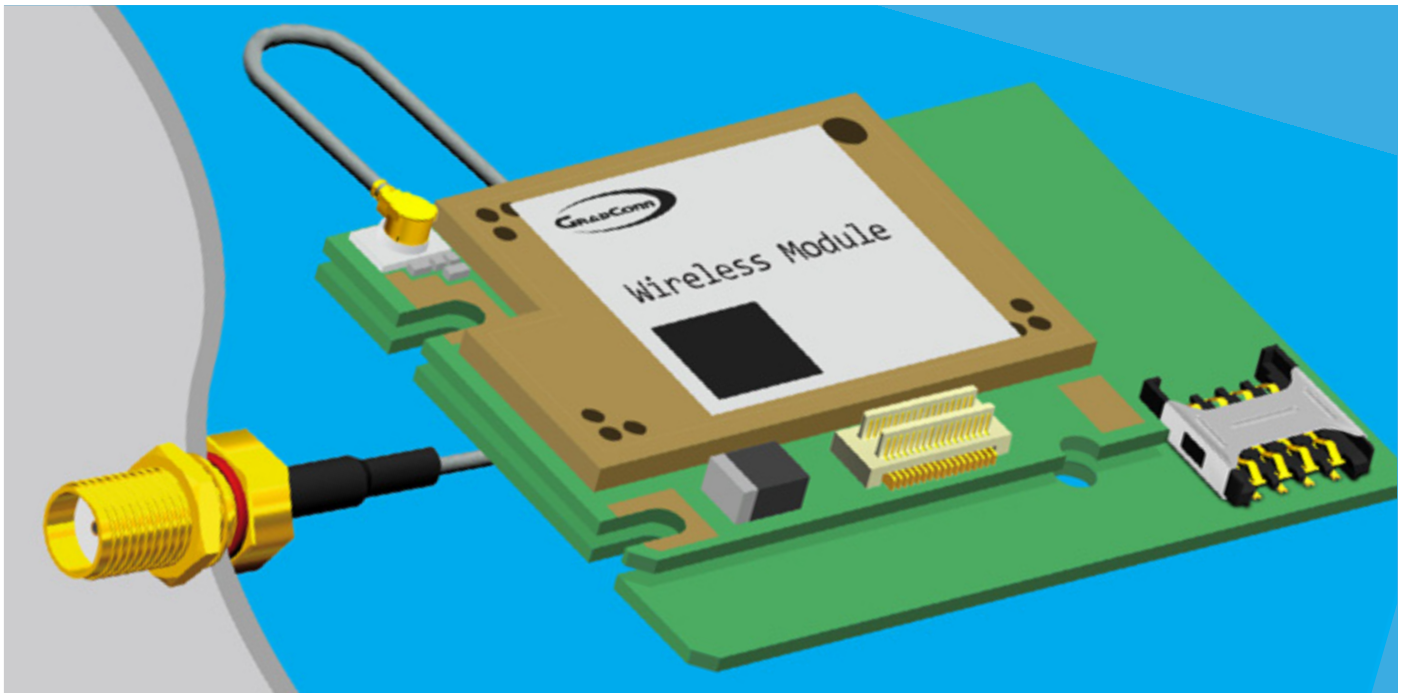

- Extensive range of drawn cable assemblies online.
- Online cable assembly builder.
- Huge range of micro and interface connector options.
- Original Hirose and Murata micro connectors.
- Economical micro connector options from I-Pex.
- Stripped and tinned cables.
- IP68 Nautilus assemblies.
- Test Probe assemblies.



Coaxial Cable Assemblies

Typical Micro Coaxial Cable Assembly Application

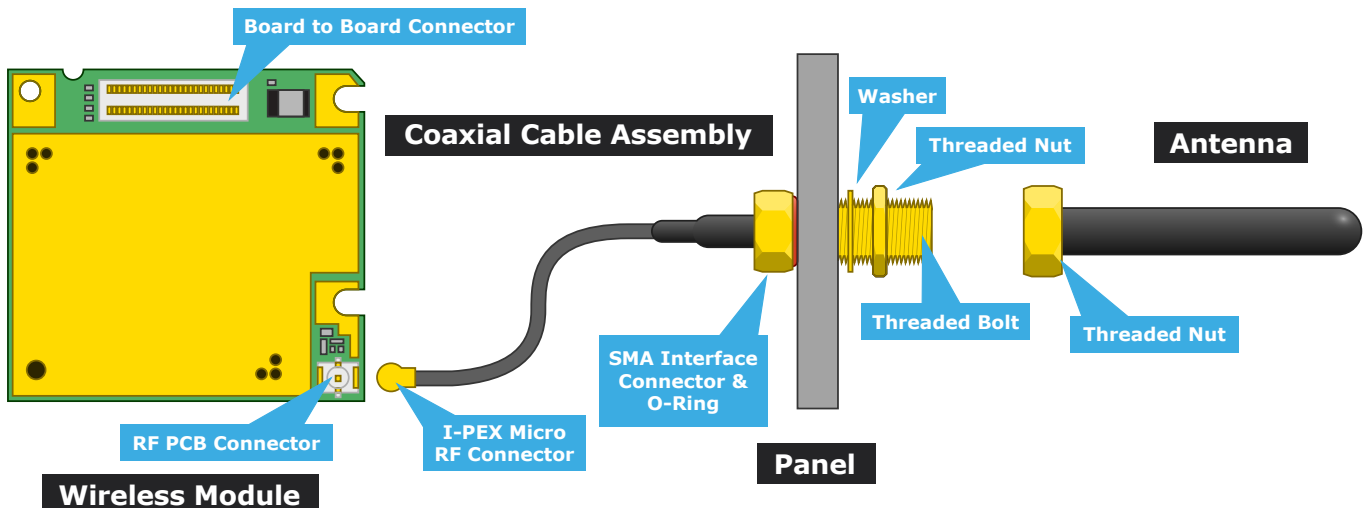

Coaxial Connector Types

Micro Connectors

Hirose H.FL 	Hirose U.FL 	Hirose W.FL 	Other connector types available on request.	
I-Pex MHF I 	I-Pex MHF I LK 	I-Pex MHF II 	I-Pex MHF III 	I-Pex MHF 4
MCX Straight Plug 	MCX Right Angle Jack 	MCX Right Angle Plug 	MMCX Straight Plug 	MMCX Right Angle Plug
Murata HSC 	Murata JSC 			

Interface Connectors

BNC Straight Bulkhead Jack 	BNC Straight Bulkhead Jack - Front Mount 	BNC Right Angle Plug 	FME Straight Jack 	FME Straight Bulkhead Plug
TNC Straight Bulkhead Jack 	TNC Straight Bulkhead Jack - RP 	TNC Straight Bulkhead Jack - Front Mount 	TNC Straight Bulkhead Jack - Front Mount - RP 	
N Straight Bulkhead Jack 	N Straight Bulkhead Jack - Front Mount 	N Straight Bulkhead Jack - RP 		
SMA Straight Bulkhead Jack 	SMA Straight Bulkhead Jack - Front Mount 	SMA Bulkhead Jack Front Mount - RP 	SMA Straight Bulkhead Jack - RP 	SMA PCB Mount Jack Cable Type
SMA PCB Mount Jack Cable Type - RP 	SMA Right Angle Bulkhead Jack 	SMA Straight Plug 	SMA Straight Plug - RP 	SMA Right Angle Plug
SMB Straight Bulkhead Jack 	SMB Straight Plug 	SMB Right Angle Plug 	SMC Straight Bulkhead Jack 	

⊕ = Reverse Polarity (RP)

○ = Optional O-Ring for thru-panel water resistance

● = Optional IP67 & IP68 rated for particle and moisture ingress protection (See page 32 - Nautilus)

Coaxial Cable Assembly Information

Stripped & Tinned Cable

Stripped cable with tinned centre conductor and braid, used for solder termination of cable assemblies to a printed circuit board. If the braid length is less than 10.00mm then the braid itself will be tinned, for lengths of 10.00mm or above a piece of tinned flexible copper wire is soldered to the braid.



Frequency Range by Application

Application	Frequency	Popular Interface Connector Types
Bluetooth	2.4 GHz	RP SMA
GPS	1,575 MHz	SMA
GSM (EUR)	900 or 1,800 MHz	SMA, FME
IMS	125 KHz to 50 GHz	Various
UMTS (USA)	1,900 or 2,100 MHz	SMA, FME
WiFi	2.4 GHz	RP TNC
WIMAX	2.4 GHz (mainly)	RP SMA
WLAN	2.4 GHz or 5.8 GHz	RP SMA - Choose appropriate connector at either 3 or 6 GHz.
Zigbee	2.4 GHz	SMA or RP SMA

This is a quick reference guide. GradConn accept no responsibility for incorrect product choice. Check technical specifications of your wireless device to find the correct cable and test samples before volume order.

Connector Orientation

Customers may specify the orientation of right angle connectors within assemblies longer than 40mm. See cable assembly drawings for details.

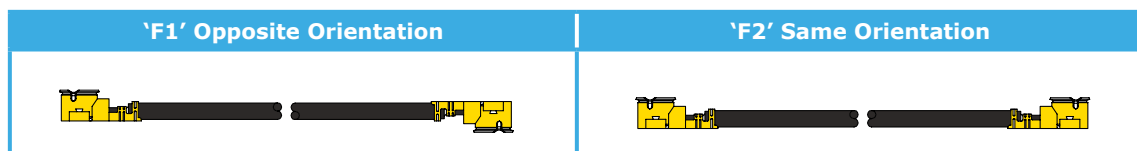

Cable Information

- Wide variety of cable diameters available from $\varnothing 0.80\text{mm}$ to RG58 and beyond.
- Assemblies are available in lengths to suit your design, from 25mm to 2000mm.
- Special cable types such as Double Shielded or PTFE available request.
- Cable specifications are available online.

Quality Information

- Automatic cable cut & strip machines provide stable & highly efficient production.
- Strict production processes increase stability of quality control.
- All cables 100% electrical conductivity tested.
- Frequency analysis reports (insertion loss and VWSR) available on request.
- 100% production testing available on request.

Nautilus Waterproof Coaxial Cable Assemblies



Nautilus is a range of panel-mounted waterproof coaxial cable assemblies which offer IP67 & IP68 protection from moisture and particle ingress, both mated and unmated.

An internal seal and panel mount O-Ring prevents ingress of water and dust particles through the inner contact or panel cut out. The Nautilus connectors have been stringently tested, for example IPx8 is tested to five meters underwater for a twelve hour period. Applications include remote monitoring, metering, asset tracking and security.

Find a range of existing IP rated cable assemblies online, or alternatively create your own custom Nautilus cable assembly using GradConn's online coaxial cable assembly builder. Multiple connector options are available, from SMA, TNC, TNB and N-Type interfaces, in rear, front, and PCB mounted options, and in standard and reverse polarity. For the other end of the cable assembly you may choose from a large range of micro and standard coaxial connectors.

Nautilus Connector Range

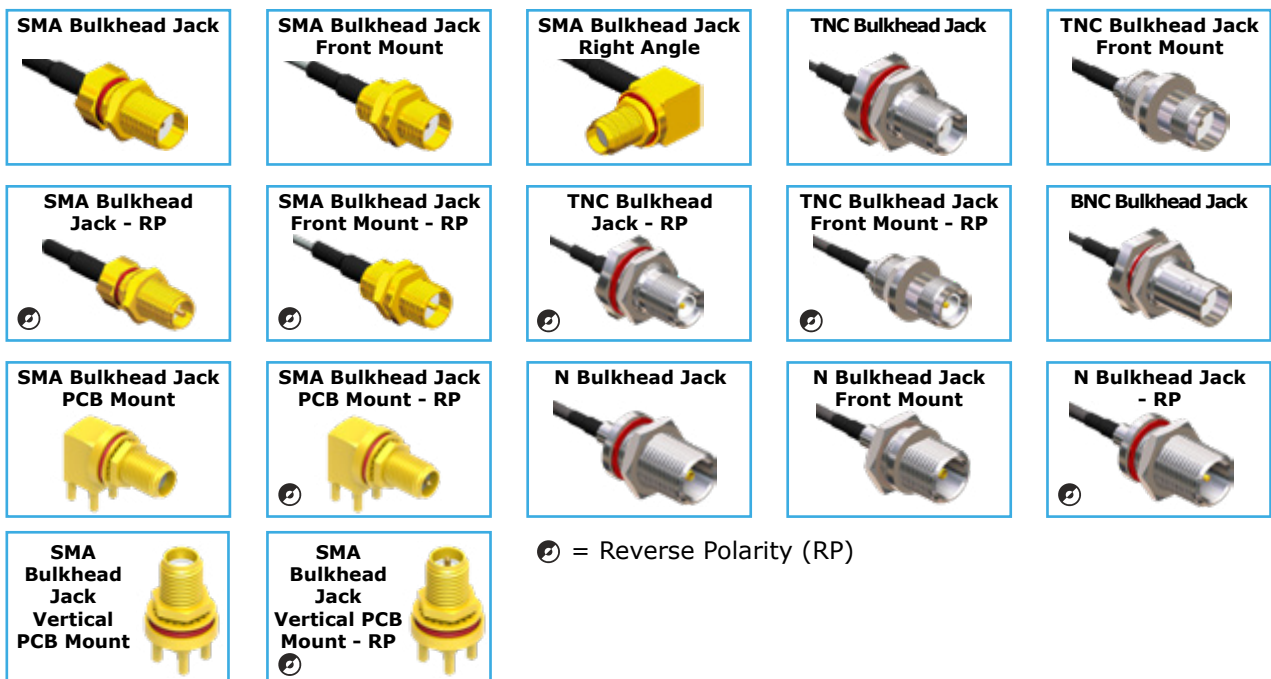

Nautilus Waterproof Coaxial Cable Assemblies

The Problem

Moisture and particles may ingress through panel and through the connector centre contact. Customers in many industries seek a fully sealed solution, from splash-proof to being fully immersed in water.

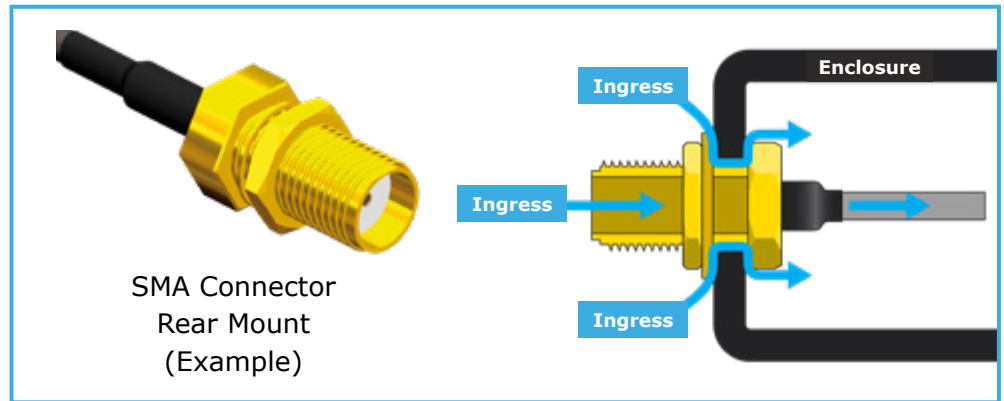

The Nautilus Solution

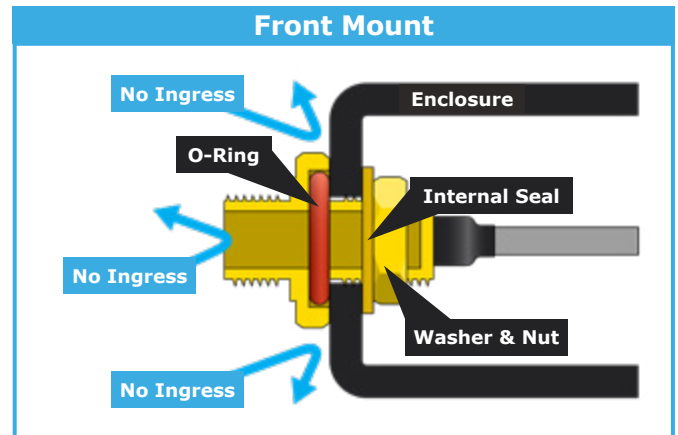
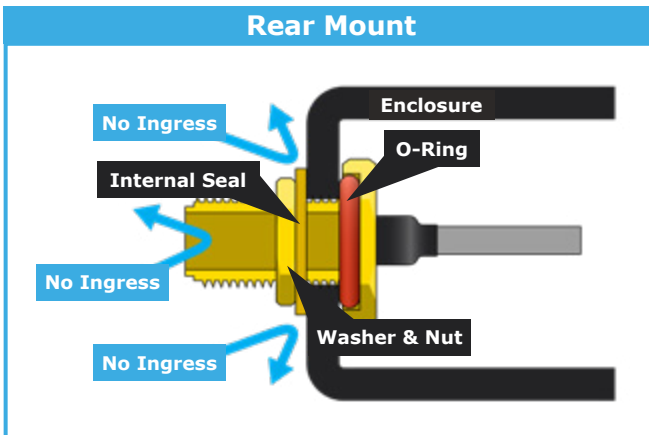

An O-Ring and inner seal provide protection from ingress from the inner contact and between the connector and bulkhead cut out.

Standards & Testing

Connectors are tested to the following exacting specifications:

- i. IP 6x Dust tight – no particle ingress.
- ii. IP x7 Waterproof for 30 minutes up to 1 meter underwater.
- iii. IP x8 Waterproof for 48 hours at 1 meter underwater.
- iv. IP x8 Waterproof for 12 hours at 5 meters underwater.
- v. Pressure test – 1 bar = 14.5 PSI (pounds/square inch) for 10 seconds.

Detailed test reports and video are available at www.gradconn.com



Coaxial Test Probes

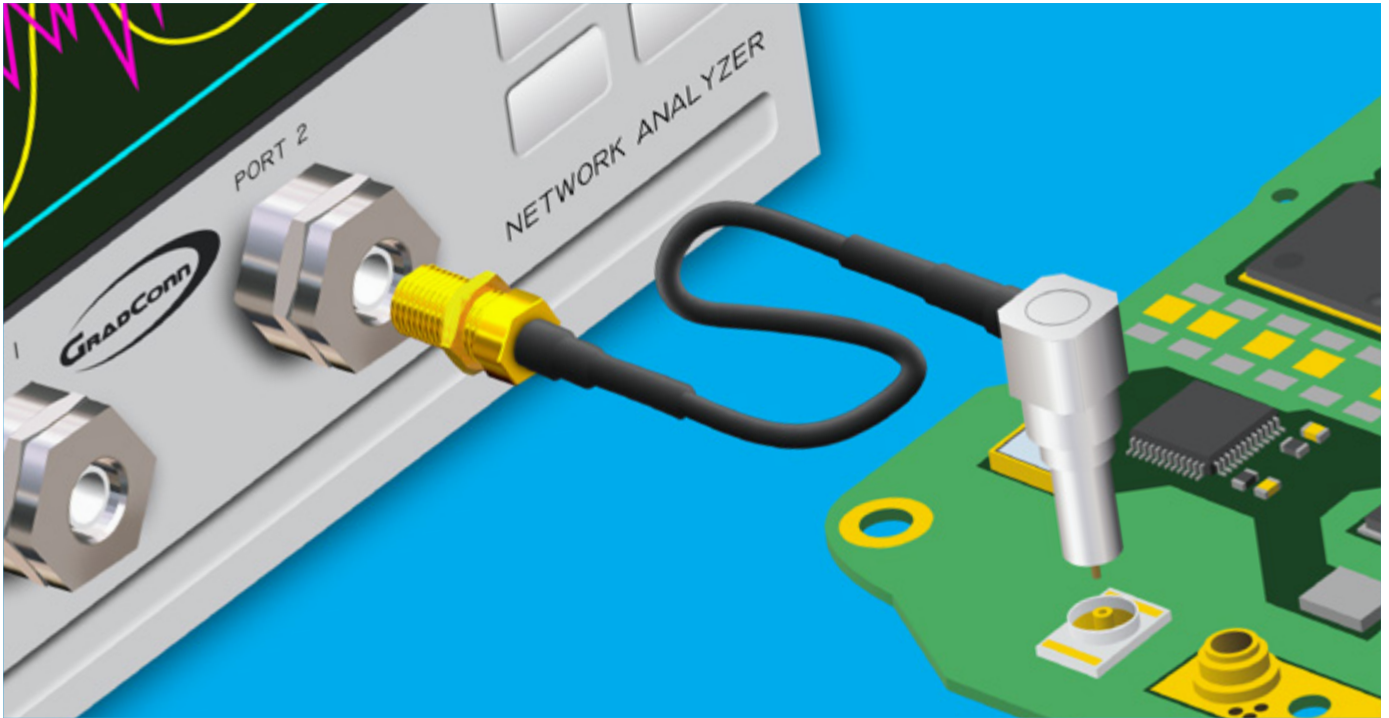

In line with its strategy for new product development GradConn has launched a new range of low cost co-axial test probe cable assemblies for the inspection of high frequency circuits.

Suitable for testing Hirose MS-156 and Murata MM8030 sub miniature coaxial switch connectors, the new probes offer reliable testing of RF circuits from development through to final production. Mating with Hirose PCB connectors MS156-C (358-0251-2) and MS156 (358-0167-8) the test probe cable assemblies have a mating test cycle durability of 500 operations and 2000 with Murata MM8030-2610.

Coaxial Cable Assemblies

Test Probes

Right Angle Crimp Type



Mates with:
Hirose MS156,
Hirose MS156-HF

Right Angle Crimp Type



Mates with:
Murata
MM8030-2610

Right Angle Crimp Type



Mates with:
Hirose
MS156-C

Online Coaxial Cable Builder

Choose from over 100 existing Cable Assemblies. If you can't find the exact part you seek you may build a custom cable, defining connector type and orientation, cable length, diameter and frequency.

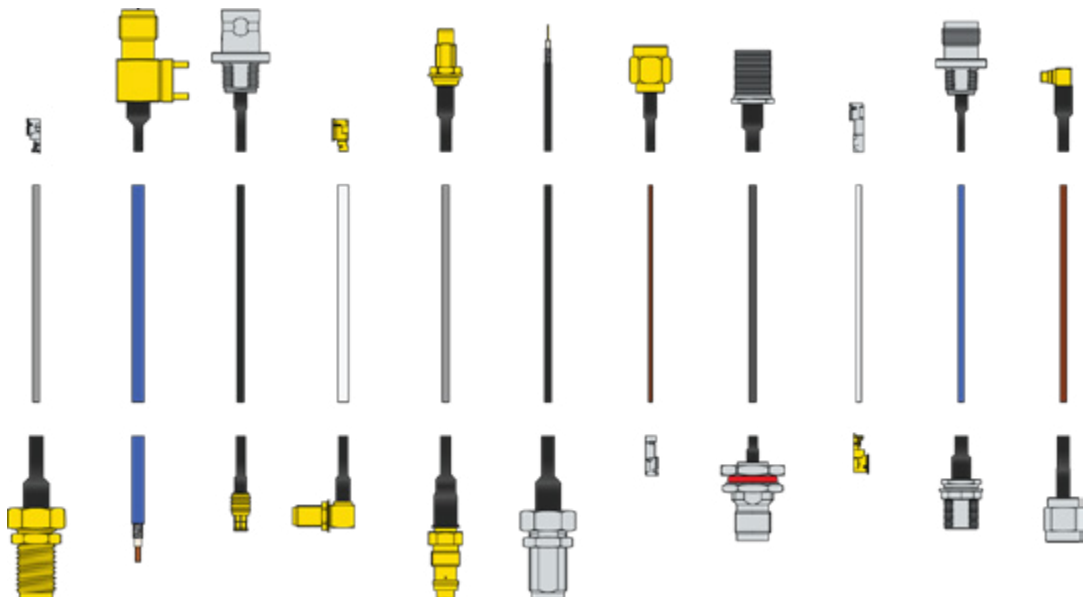

SIM Card Connectors

Subscriber Identity Module (SIM) cards are available in numerous varieties. GradConn offer connectors for the three standard SIM card types - Mini (2nd Form Factor - 2FF), Micro (3FF) & Nano (4FF) in five connector types.

MINISIM (2FF)

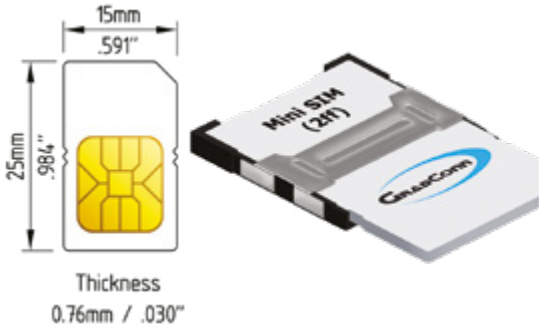

MICROSIM (3FF)

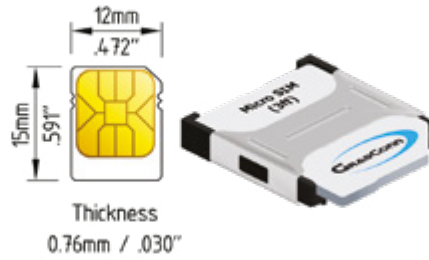

NANOSIM (4FF)



- **Push-Push:** Push card into place, another push operates a spring which automatically ejects the card.
- **Push-Pull:** An economical option. Card slots into place and is held by contact force and friction.
- **Hinged:** Cards are inserted into a hinged cover, the hinge is closed, then locked into place.
- **Dual:** Accepts two SIM cards, saving space and allowing applications such as dual network.
- **Contact:** Connector with contacts only, no means of holding the card in place.

Connector Type

Push-Push	Push-Pull	Hinged	Dual	Contact

Card Size	NANOSIM					
	MICROSIM					
	MINISIM					

Nano SIM Card Connectors

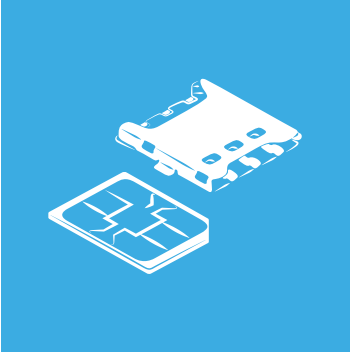

The Nano SIM card (also known as 4FF or 4th form factor) measures only 8.8mm x 12.3mm (.346" x .484") and has a 0.67mm (.026") thickness. The contact arrangement is identical to Mini and Micro SIM cards.

GradConn's CH03-KB includes card stop functionality which prevents the Nano SIM card being inserted in an incorrect orientation, either upside down or the wrong way around.

CH03-KB

Style: Push-Pull

Card Type: Nano 4FF

Number of Contacts: 6

Height: 1.35mm

Switch: No

Durability: 1,500 cycles

Locating Peg: Optional

Packing: Tape & Reel (of 1500)



Communication really is making the world smaller. The ever-expanding demand for mobile connectivity combined with the desire for smaller lighter devices has led to a number of developments in both mobile devices and SIM cards themselves.

The latest addition to GradConn's SIM Card Connector family reflects this. CH03-KB, our smallest SIM product, is ideal when space is at a premium, for example hand held devices or wearable mobile products. Our Nano SIM connector is a 6 contact, push-pull connector that measures 12.3mm x 9.8mm with a 1.35mm profile. It's rated for 1,500 card insertion cycles and has an operating temperature range of -40° to +85°C. Accurate PCB placement is achieved via the locating pegs; hold downs offer PCB retention strength.



Micro SIM Card Connectors

The Micro SIM card (also known as 3FF or 3rd form factor) measures only 12mm x 15mm (.472" x .59") and has a 0.76mm (.029") thickness. Contact arrangement is identical to the standard Mini card. Micro cards use the same size and position of pads as Mini SIM.

The optional solder tab provides extra physical strength and grounding for parts with a metal shell, and an optional card detection switch is designed to detect the presence of a SIM card when inserted.

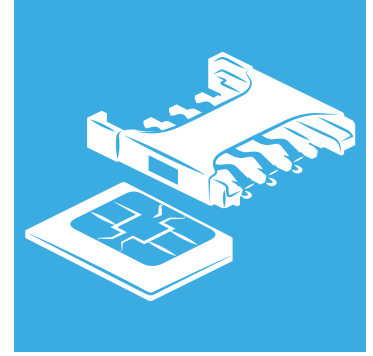

CH03-FB

Best Price!

Style: Push-Pull

Card Type: Micro 3FF

Number of Contacts: 6 or 8

Height: 2.40mm

Switch: No

Durability: 5,000 cycles

Locating Peg: No

Packing: Tape & Reel (of 900)

CH03-GB

Style: Push-Push

Card Type: Micro 3FF

Number of Contacts: 6 or 8

Height: 1.50mm

Switch: Yes, Normally Closed

Durability: 1,500 cycles

Locating Peg: No

Packing: Tape & Reel (of 1000)

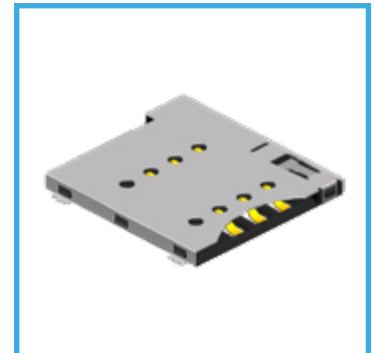

Micro SIM Card Connectors

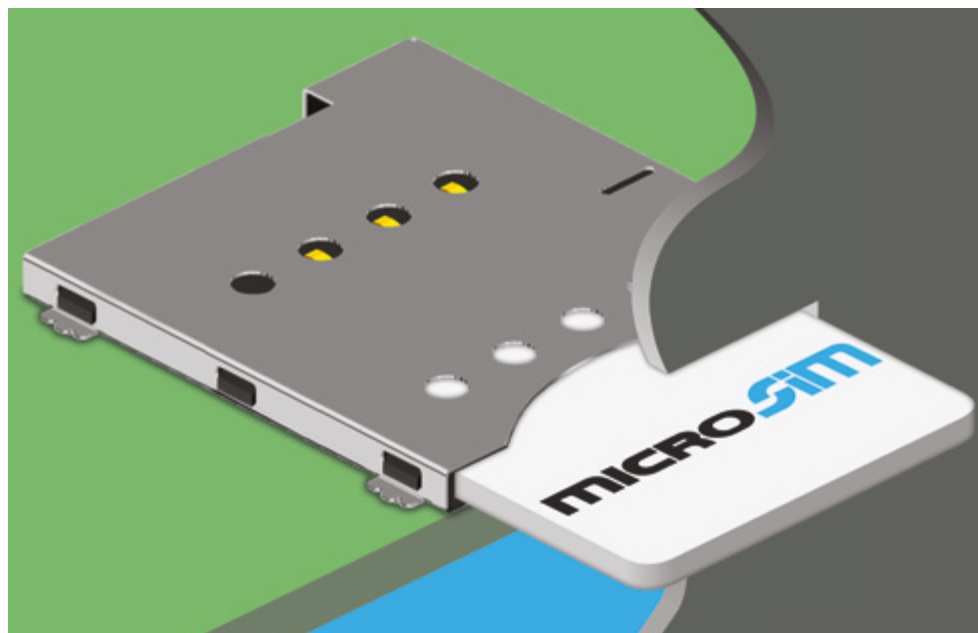

Push-Push type SIM connectors allow a Micro SIM card to be pushed into place, the 2nd push operates a spring which ejects the card, eliminating the need to extract the tiny card by hand.

Push-Push technology is often used in applications where the end user inserts a card from outside the equipment, the connector is normally mounted on the edge of a PCB with the mating face accessible via customer's panel design.

Mini SIM Card Connectors

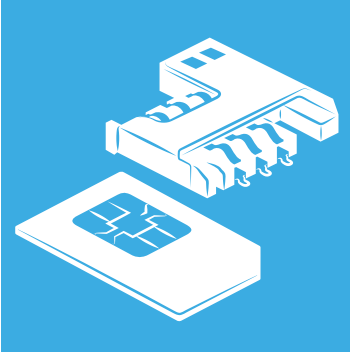

The Mini SIM card (also known as 2FF or 2nd Form Factor) standard reference is ISO/IEC 7810:2003. The card itself measures 25.00mm x 15.00mm (.984" x .59") with a thickness of 0.76mm (.029"). For reference, a full-sized 1FF SIM card is the size of a bank card, and was phased out in the mid 1990's as the 2FF Mini SIM became ubiquitous with use in mobile telephones.

Push-Push Mini SIM Card Connectors

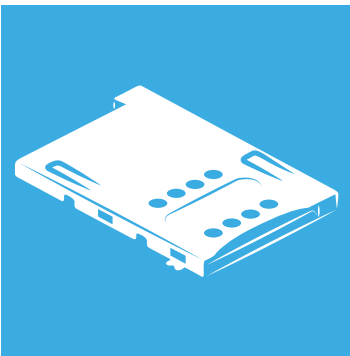

Push-push surface mount SIM connectors operate with either 6 or 8 contact pins. This connector type allows the user to push a SIM card into place, and a second push operates a spring which pushes the card out. This removes the need to extract small cards by hand. An optional card detection switch is designed to detect the presence of a SIM card when inserted.

Push-Push is normally used in applications where the end user inserts a card from outside the equipment. The connector is normally mounted on the edge of a PCB with the mating face accessible via a cut-out in the panel design. The metal shell provides resistance to heat damage.

Mini SIM Card Connectors

CH03-DD-A

Style: Push-Push
Card Type: Mini 2FF
Number of Contacts: 6 or 8
Height: 1.90mm

Switch: Yes (Normally Closed)
Durability: 5,000 cycles
Locating Peg: Optional
Packing: Reel (of 600)



CH03-DD-B

Style: Push-Push
Card Type: Mini 2FF
Number of Contacts: 6 or 8
Height: 1.90mm

Switch: No
Durability: 5,000 cycles
Locating Peg: No
Packing: Reel (of 600)

CH03-DE

Style: Push-Push
Card Type: Mini 2FF
Number of Contacts: 6 or 8
Height: 1.80mm

Switch: Yes (Normally Open)
Durability: 5,000 cycles
Locating Peg: No
Packing: Reel (of 900)



Push-Pull Mini SIM Card Connectors

Push-Pull type connectors work by the user pushing the SIM card into place. The card is held in place against the plastic frame or metal shell by the force of the contacts, and the card is removed by pulling by hand. The optional solder tab provides extra physical strength and grounding for parts with a metal shell. An optional card detection switch is designed to detect the presence of a card when inserted, and optional locating pegs hold the connector in place during the SMT reflow solder process.

This connector type is an economical option and often used in fit and forget solutions where the card is rarely (or never) plugged and unplugged.

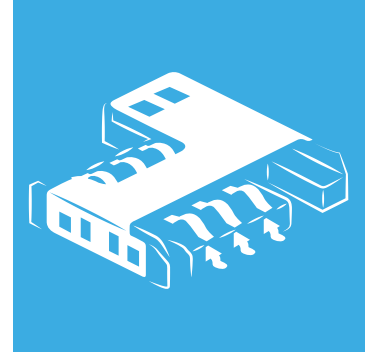

CH03-AA-A

Style: Push-Pull

Card Type: Mini 2FF

Number of Contacts: 6 or 8

Height: 2.40mm

Switch: Yes (Normally Open)

Durability: 10,000 cycles

Locating Peg: Optional

Packing: Tube or Reel

CH03-AA-B

Style: Push-Pull

Card Type: Mini 2FF

Number of Contacts: 6 or 8

Height: 2.40mm

Switch: No

Durability: 10,000 cycles

Locating Peg: Optional

Packing: Tube or Reel



Mini SIM Card Connectors



CH03-AJ

Style: Push-Pull

Card Type: Mini 2FF

Number of Contacts: 6

Height: 3.42mm

Switch: Yes (Normally Open or Closed)

Durability: 5,000 cycles

Locating Peg: Optional

Packing: Reel (of 700)

CH03-AL

Style: Push-Pull

Card Type: Mini 2FF

Number of Contacts: 6 or 8

Height: 1.80mm

Switch: No

Durability: 5,000 cycles

Locating Peg: No

Packing: Reel (of 1000)

Best Price!

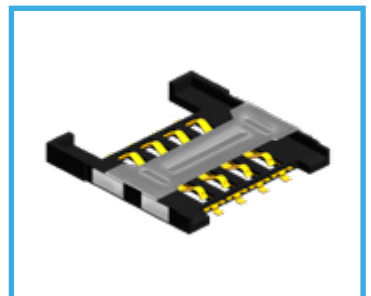

Hinged Mini SIM Card Connectors



Hinged SIM connectors allow operators to insert the SIM card into a hinged cover, that cover holds the SIM card in place, the hinge is closed, then locked into place. An optional card detection switch is designed to detect the presence of a SIM card when inserted, and optional locating pegs hold the connector in place during the SMT reflow solder process.

Hinged SIM connectors are often preferred for higher vibration environments, compared to Push-Pull or Push-Push types because of the positive lock characteristics. Polarised molding ensures the cover can only be closed if the card is in the correct position.

CH03-BE

Style: Hinged
Card Type: Mini 2FF
Number of Contacts: 6 or 8
Height: 3.00mm

Switch: Yes (Normally Open)
Durability: 10,000 cycles
Locating Peg: Optional
Packing: Reel (of 600)

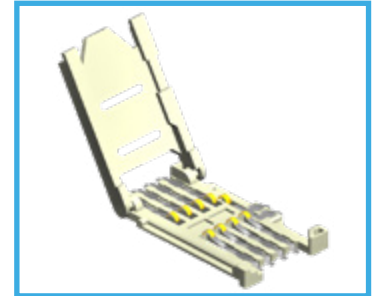

CH03-BH

Style: Hinged
Card Type: Mini 2FF
Number of Contacts: 6
Height: 2.50mm

Switch: Yes (Normally Open)
Durability: 5,000 cycles
Locating Peg: Optional
Packing: Tray (5500) or Reel (650)

Best Price!

CH03-BL

Style: Hinged
Card Type: Mini 2FF
Number of Contacts: 6 or 8
Height: 2.50mm

Switch: No
Durability: 5,000 cycles
Locating Peg: Optional
Packing: Reel (of 800)

Best Price!



Dual Mini SIM Card Connectors

Dual connectors allow for the plugging of two SIM cards into a single connector. This saves physical space on the PCB and cuts the cost of PCB placement.

In the push-pull configuration, the SIM cards slot into place and are held by friction. The cards are not locked in place and are removed manually. The metal shell provides resistance to heat damage.



CH03-AN

Style: Dual

Card Type: Mini 2FF

Number of Contacts: 8

Height: 3.00mm

Switch: No

Durability: 5,000 cycles

Locating Peg: No

Packing: Reel (of 700)

Contact Mini SIM Card Connectors

A 'contact' SIM Connector describes a connector with open contacts and no integral means of holding SIM card in place. That is handled by the customer's own design, usually by means of a plastic moulding. An optional locating peg hold the connector in place during the SMT reflow solder process.

Contact type connectors are suitable for Mini (2ff) and Micro (3ff) and Nano (4ff) SIM cards as there is no change in SIM card contact design between all three GSM card specifications.



CH03-CJ

Style: Contact

Card Type: All

Number of Contacts: 8

Height: 1.30mm

Switch: No

Durability: 100,000 cycles

Locating Peg: Optional

Packing: Tube (of 40)

Find your perfect solution, fast!



**Custom Wire
to Board Cable
Assembly Builder**

**Search Filter
Options**

**Coaxial Cable
Assembly Builder**

**Optimised for
Mobile Devices**

**Board to Board
Stacking Height
Calculator**

**Up-to-Date
Information**

GradConn Americas
1825 NW Corporate Blvd
Suite 110, Boca Raton
Florida, 33431
USA
+1 (954) 903 3394
SalesUSA@GradConn.com

GradConn Asia
209 Minsheng Road
Longtan District
Taoyuan City
Taiwan 32554
+886-3-499-3132
Sales@GradConn.com

GradConn Europe
International House
61 Mosley Street
Manchester, M2 3HZ
United Kingdom
+44 (0)208 236 0005
SalesEurope@GradConn.com

2019 Edition



**Board to Board Connectors
Wire to Board Solutions
Coaxial Cable Assemblies
SIM Card Connectors**

www.GradConn.com